

CW 60

CW 60

R

REYNAERS
aluminium

Edition 11/2010 (based on 089.C52D.00)

CW 60



CW 60

- 1 Structure
- 2 Esthétique extérieure
- 3 Eléments fixes
- 4 Eléments ouvrants
- 5 Raccordements

CW 60-HI

CW 60-HL

CW 60 Structural Clamped (CW 60-SC)

CW 60 Structural Glazing (CW 60-SG)



1 Structure interne

Structure interne verticale

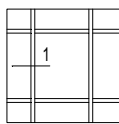

CW 60 - 002

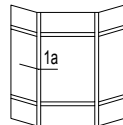

CW 60 - 002

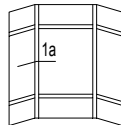

CW 60 - 002

Structure interne horizontale

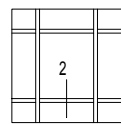

CW 60 - 004

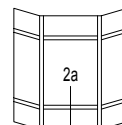

CW 60 - 004

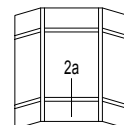

CW 60 - 004

2 Esthétique extérieure

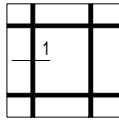

CW 60 - 007

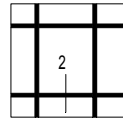

CW 60 - 008

3 Éléments fixes

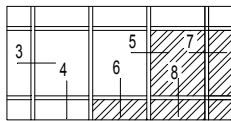

CW 60 - 009

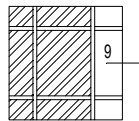

CW 60 - 011

4 Éléments ouvrants

Fenêtres

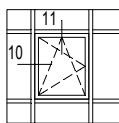

CW 60 - 012

Fenêtres avec ouvrant caché

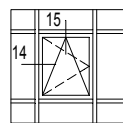

CW 60 - 013

Fenêtres avec ouvrant VEC

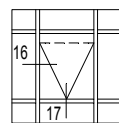

CW 60 - 014

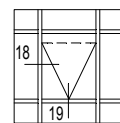

CW 60 - 016

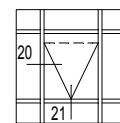

CW 60 - 018

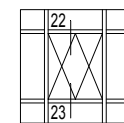

CW 60 - 019

Portes ouvrant vers l'intérieur

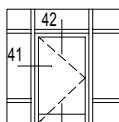

CW 60 - 024

Portes ouvrant vers l'extérieur

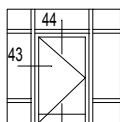

CW 60 - 025

Portes coulissantes

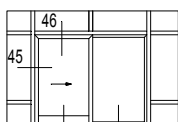

CW 60 - 026

Portes automatiques

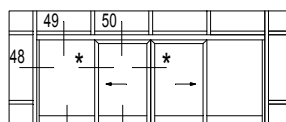

CW 60 - 027

* Autres sections : voir système correspondant où d'autres sections des parties ouvrantes sont montrées.



5 Raccordements

Solutions d'angle

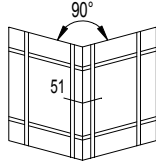

CW 60 - 030

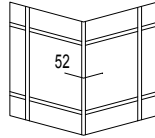

CW 60 - 032

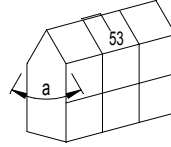

CW 60 - 033

Dilatation

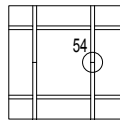

CW 60 - 034

Éléments fixes

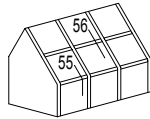

CW 60 - 036

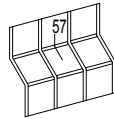

CW 60 - 038

Éléments ouvrants

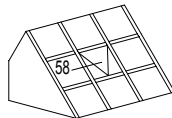

CW 60 - 039

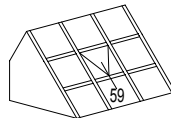

CW 60 - 040

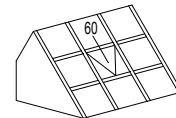

CW 60 - 041

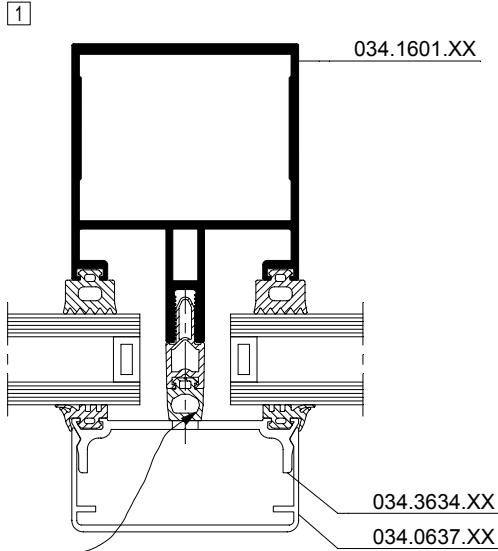
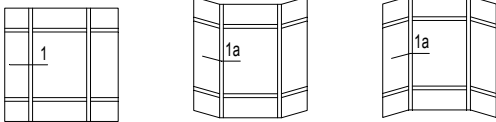

Variant
 Variante
 Variant
 Variante

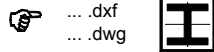

Verticale compartimentering is optioneel
 Compartmentalisation verticale est optionnelle
 Vertical compartmentation is optional
 Vertikale Kompartimentierung ist eine Option

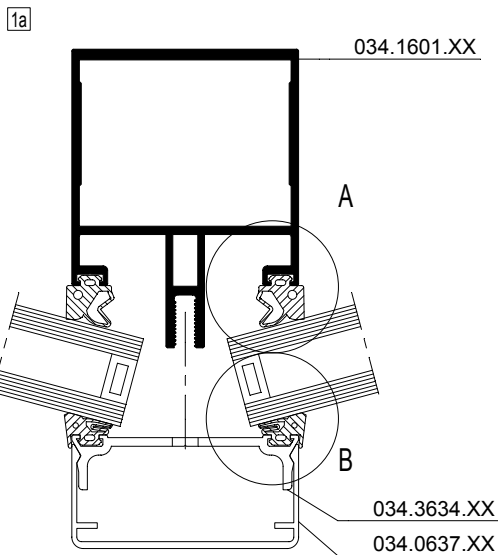

MIN. 150°

MAX. 210°

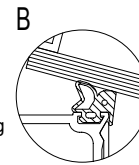
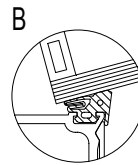
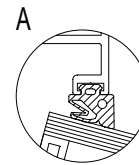
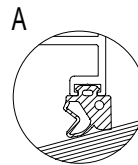

CW60-01a001.dxf
 CW60-01a001.dwg

CW60-01a002.dxf
 CW60-01a002.dwg

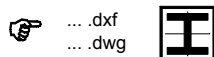

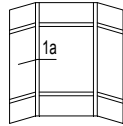
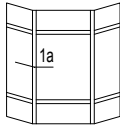
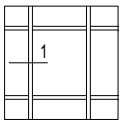

034.1601.XX

$I_x = 44.642 \text{ cm}^4$

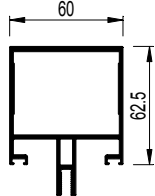

CW60-001001.dxf
 CW60-001001.dwg

034.1602.XX

$I_x = 99.298 \text{ cm}^4$

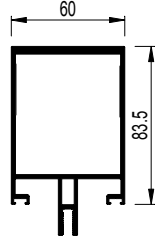

CW60-001002.dxf
 CW60-001002.dwg

034.1604.XX

$I_x = 167.949 \text{ cm}^4$

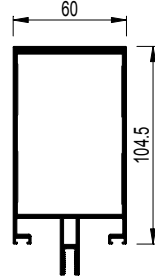

CW60-001003.dxf
 CW60-001003.dwg

034.1605.XX

$I_x = 258.583 \text{ cm}^4$

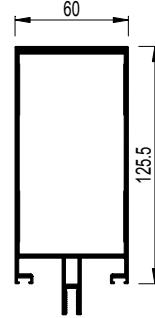

CW60-001004.dxf
 CW60-001004.dwg

034.1606.XX

$I_x = 377.487 \text{ cm}^4$

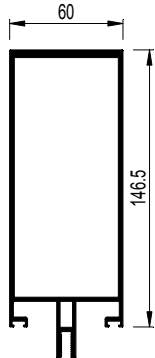

CW60-001005.dxf
 CW60-001005.dwg

034.1607.XX

$I_x = 551.226 \text{ cm}^4$

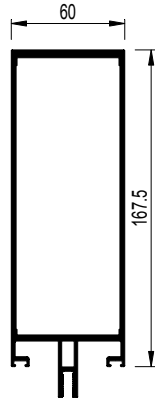

CW60-001006.dxf
 CW60-001006.dwg

034.1608.XX

$I_x = 736.559 \text{ cm}^4$

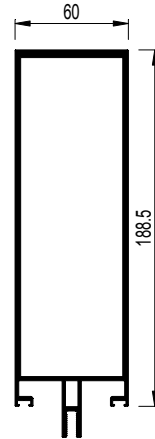

CW60-001007.dxf
 CW60-001007.dwg

034.1609.XX

$I_x = 1014.894 \text{ cm}^4$

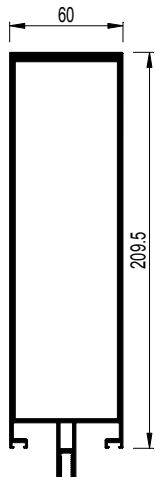

CW60-001008.dxf
 CW60-001008.dwg

034.1610.XX

$I_x = 1504.315 \text{ cm}^4$

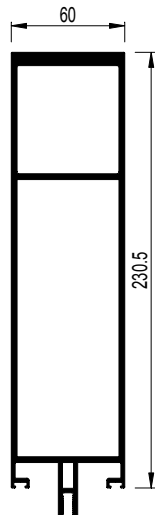

CW60-001009.dxf
 CW60-001009.dwg

034.1611.XX

$I_x = 1914.141 \text{ cm}^4$

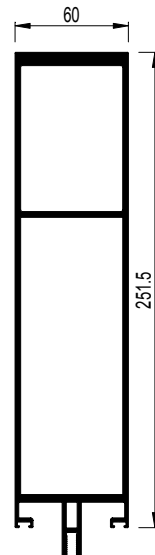

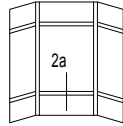
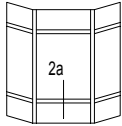
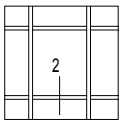

CW60-001010.dxf
 CW60-001010.dwg

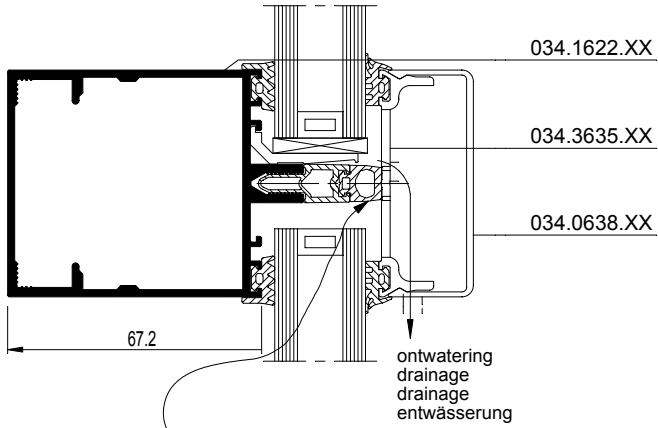

2



Horizontale compartimentering is verplicht
Compartimentation horizontale est obligatoire
Horizontal compartmentalization is obligatory
Horizontale Kompartimentierung ist verpflichtet

dxf
... .dwg 

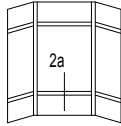
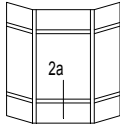
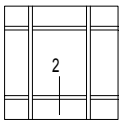

034.1622.XX

$I_x =$	45.472 cm ⁴
$I_y =$	32.822 cm ⁴

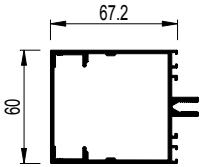

2 CW60-002001.dxf
 CW60-002001.dwg

034.1623.XX

$I_x =$	87.600 cm ⁴
$I_y =$	41.284 cm ⁴

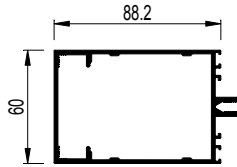

2 CW60-002002.dxf
 CW60-002002.dwg

034.1624.XX

$I_x =$	155.867 cm ⁴
$I_y =$	54.376 cm ⁴

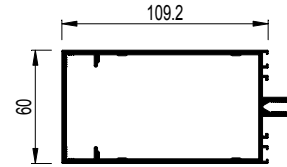

2 CW60-002003.dxf
 CW60-002003.dwg

034.1625.XX

$I_x =$	238.553 cm ⁴
$I_y =$	63.058 cm ⁴

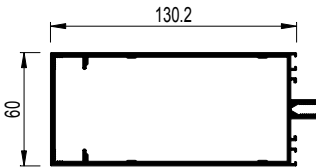

2 CW60-002004.dxf
 CW60-002004.dwg

034.1626.XX

$I_x =$	344.041 cm ⁴
$I_y =$	71.745 cm ⁴

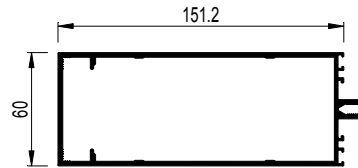

2 CW60-002005.dxf
 CW60-002005.dwg

034.1627.XX

$I_x =$	474.462 cm ⁴
$I_y =$	80.427 cm ⁴

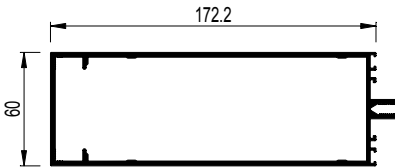

2 CW60-002006.dxf
 CW60-002006.dwg

034.1628.XX

$I_x =$	632.340 cm ⁴
$I_y =$	89.111 cm ⁴

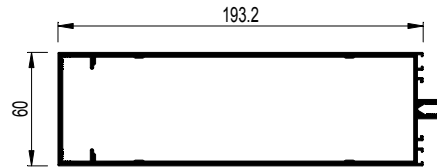

2 CW60-002007.dxf
 CW60-002007.dwg

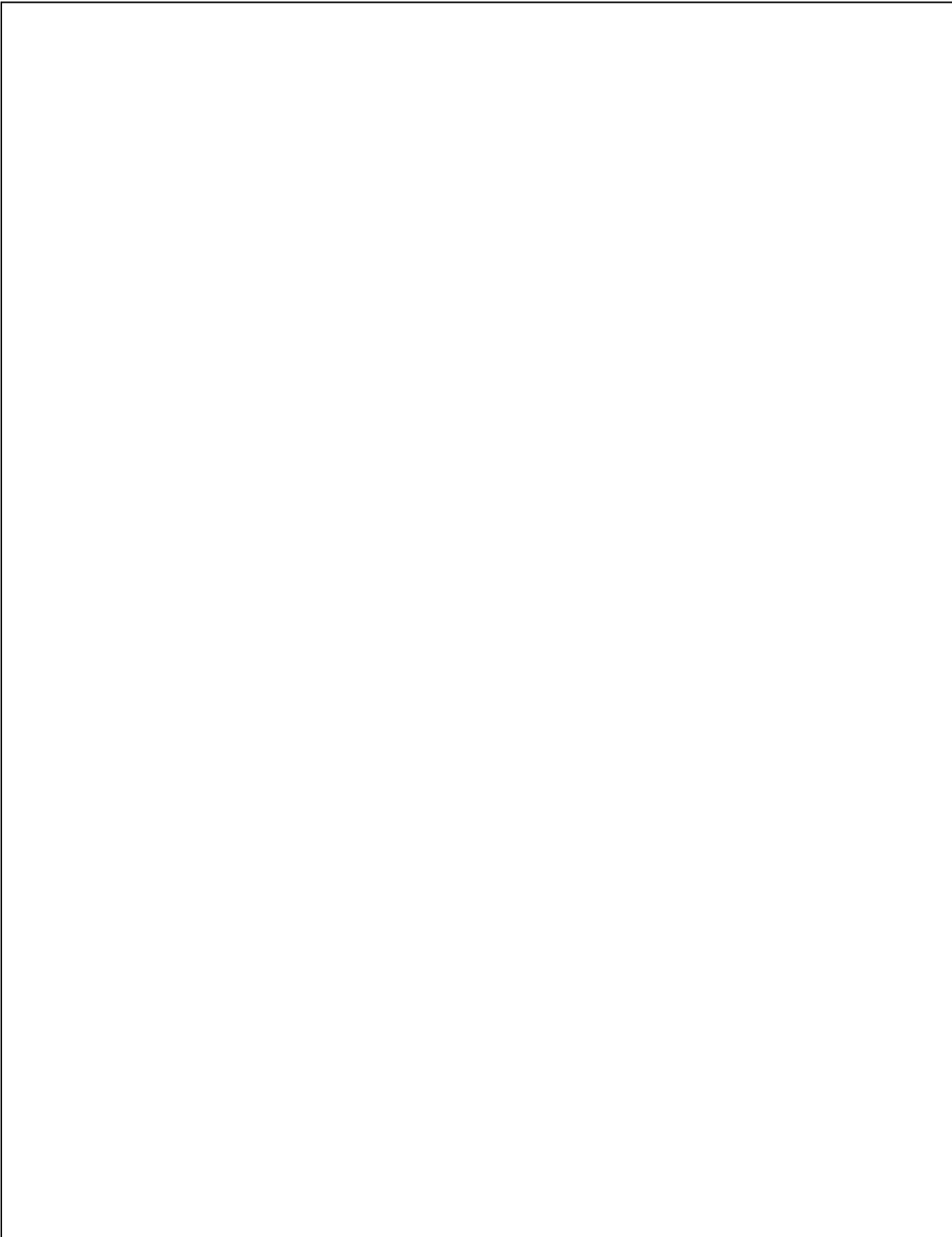

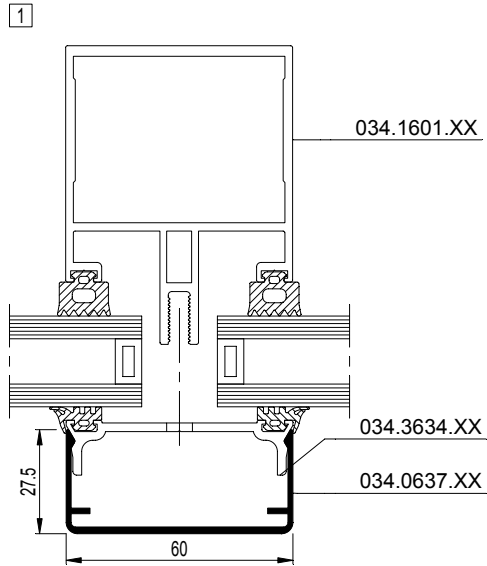
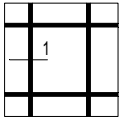

CW60-001013.dxf
 CW60-001013.dwg

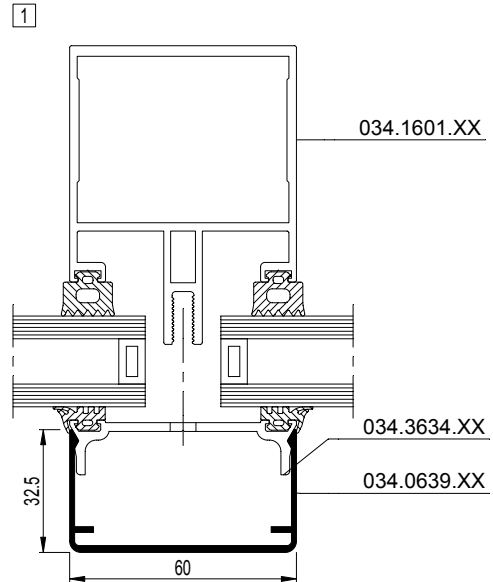

CW60-001014.dxf
 CW60-001014.dwg

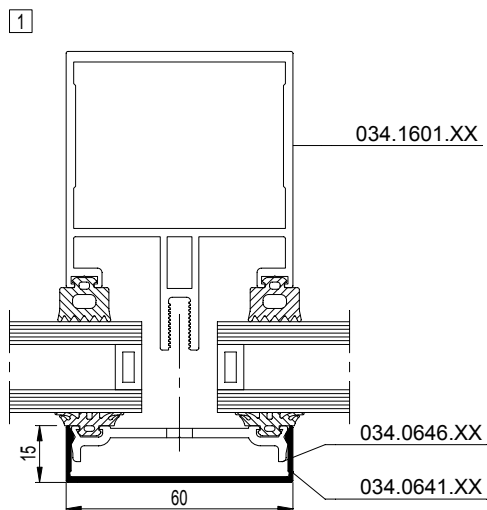

CW60-001015.dxf
 CW60-001015.dwg

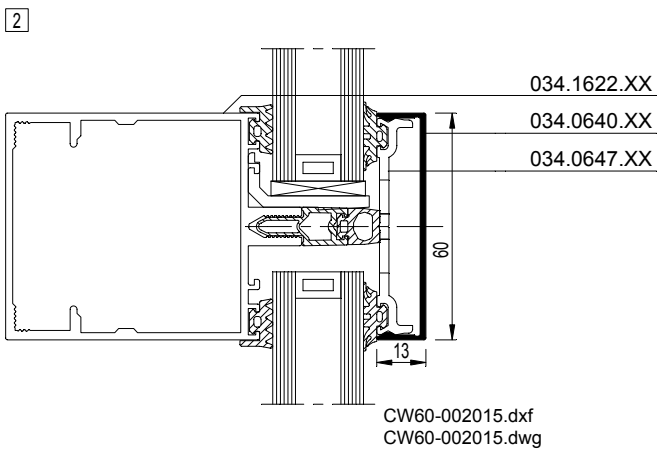
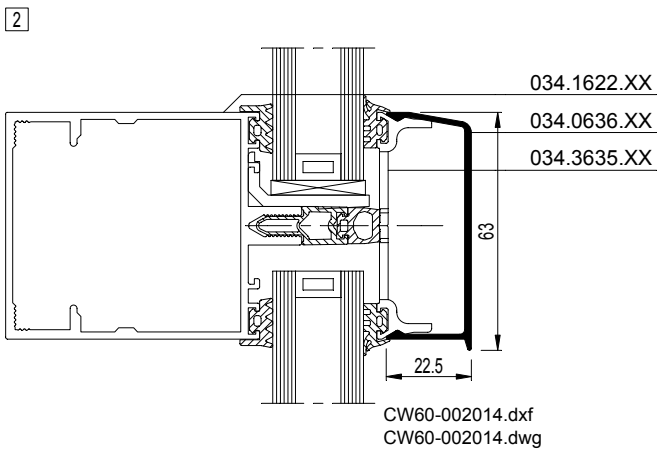
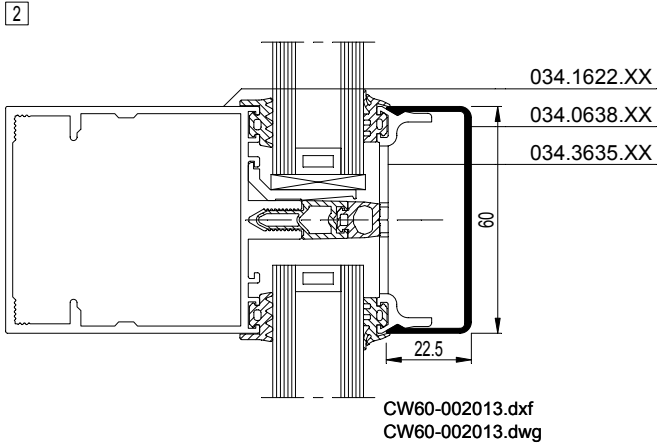
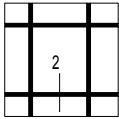

3	4	5	6	7	8

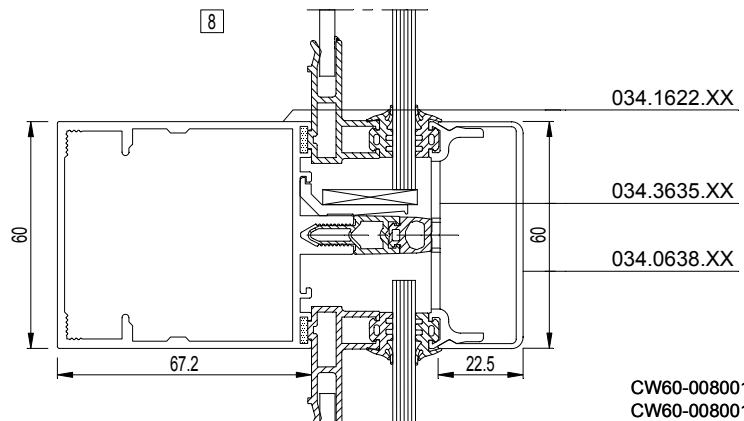
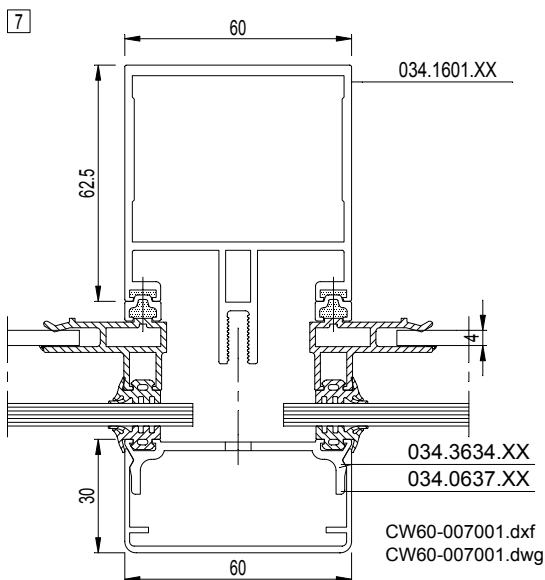
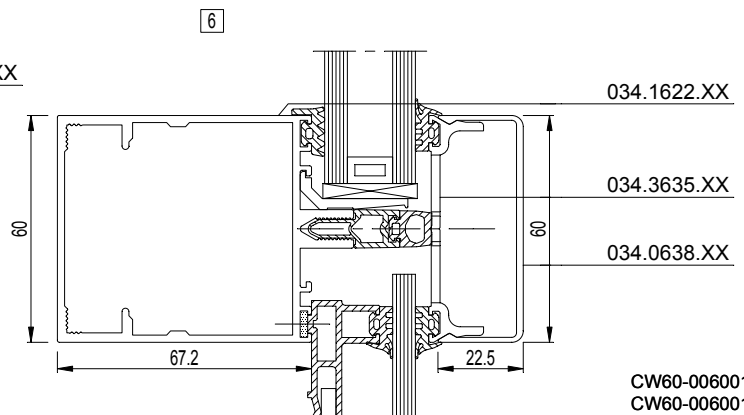
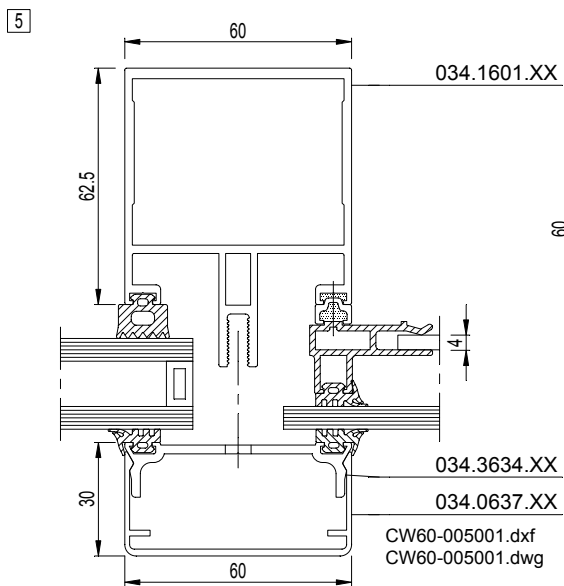
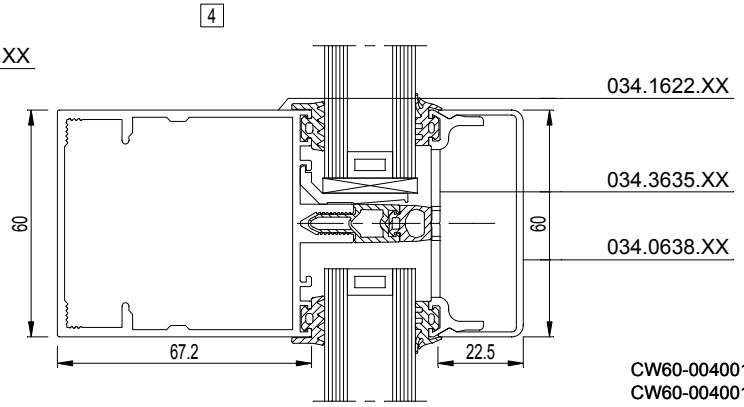
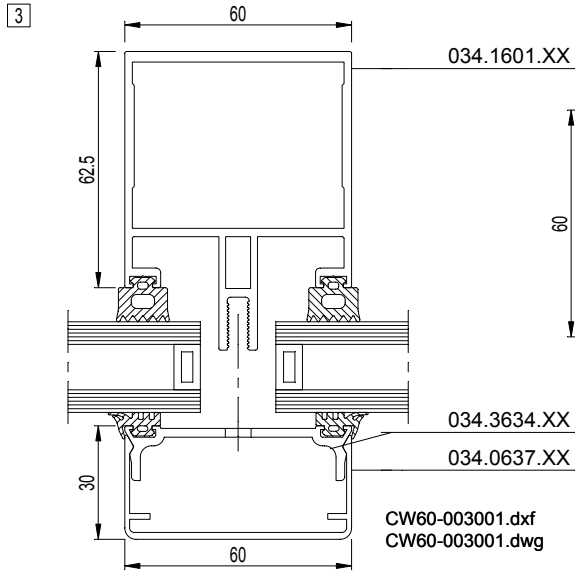

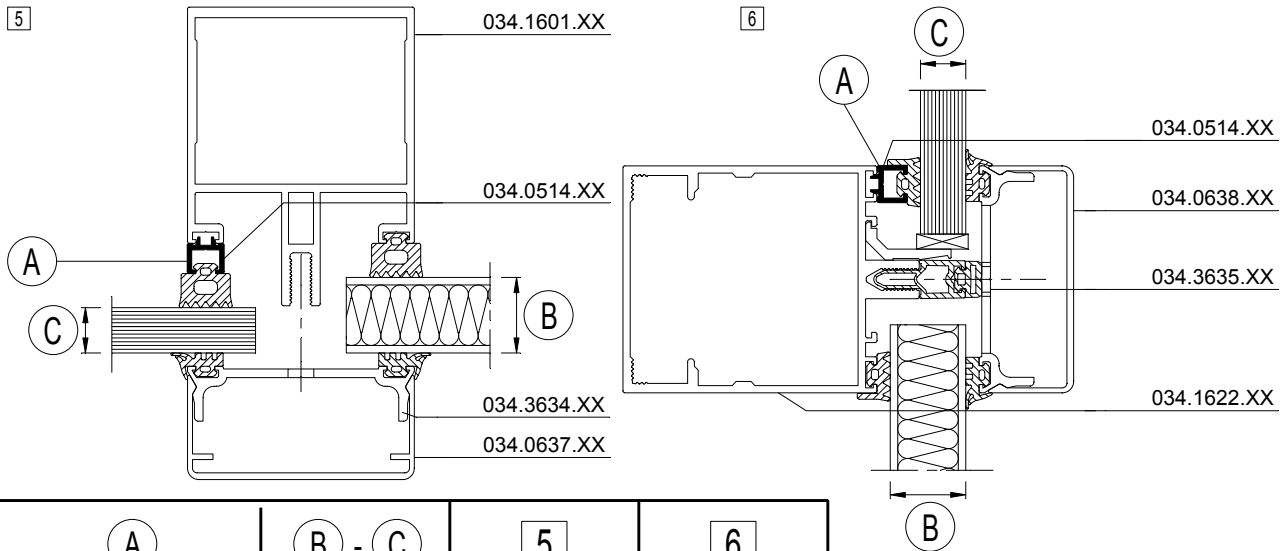
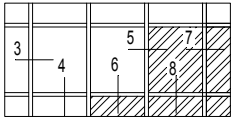

(A)	(B) - (C)	5	6
034.0517.XX		CW60-005002.dxf CW60-005002.dwg	CW60-006002.dxf CW60-006002.dwg
034.0617.XX		CW60-005003.dxf CW60-005003.dwg	CW60-006003.dxf CW60-006003.dwg
034.0514.XX		CW60-005004.dxf CW60-005004.dwg	CW60-006004.dxf CW60-006004.dwg
034.0618.XX		CW60-005005.dxf CW60-005005.dwg	CW60-006005.dxf CW60-006005.dwg
034.0615.XX		CW60-005006.dxf CW60-005006.dwg	CW60-006006.dxf CW60-006006.dwg
034.0619.XX		CW60-005007.dxf CW60-005007.dwg	CW60-006007.dxf CW60-006007.dwg
034.0610.04		CW60-005008.dxf CW60-005008.dwg	CW60-006008.dxf CW60-006008.dwg
034.0411.04		CW60-005009.dxf CW60-005009.dwg	CW60-006009.dxf CW60-006009.dwg
034.0616.XX		CW60-005010.dxf CW60-005010.dwg	CW60-006010.dxf CW60-006010.dwg
034.0420.XX		CW60-005011.dxf CW60-005011.dwg	CW60-006011.dxf CW60-006011.dwg

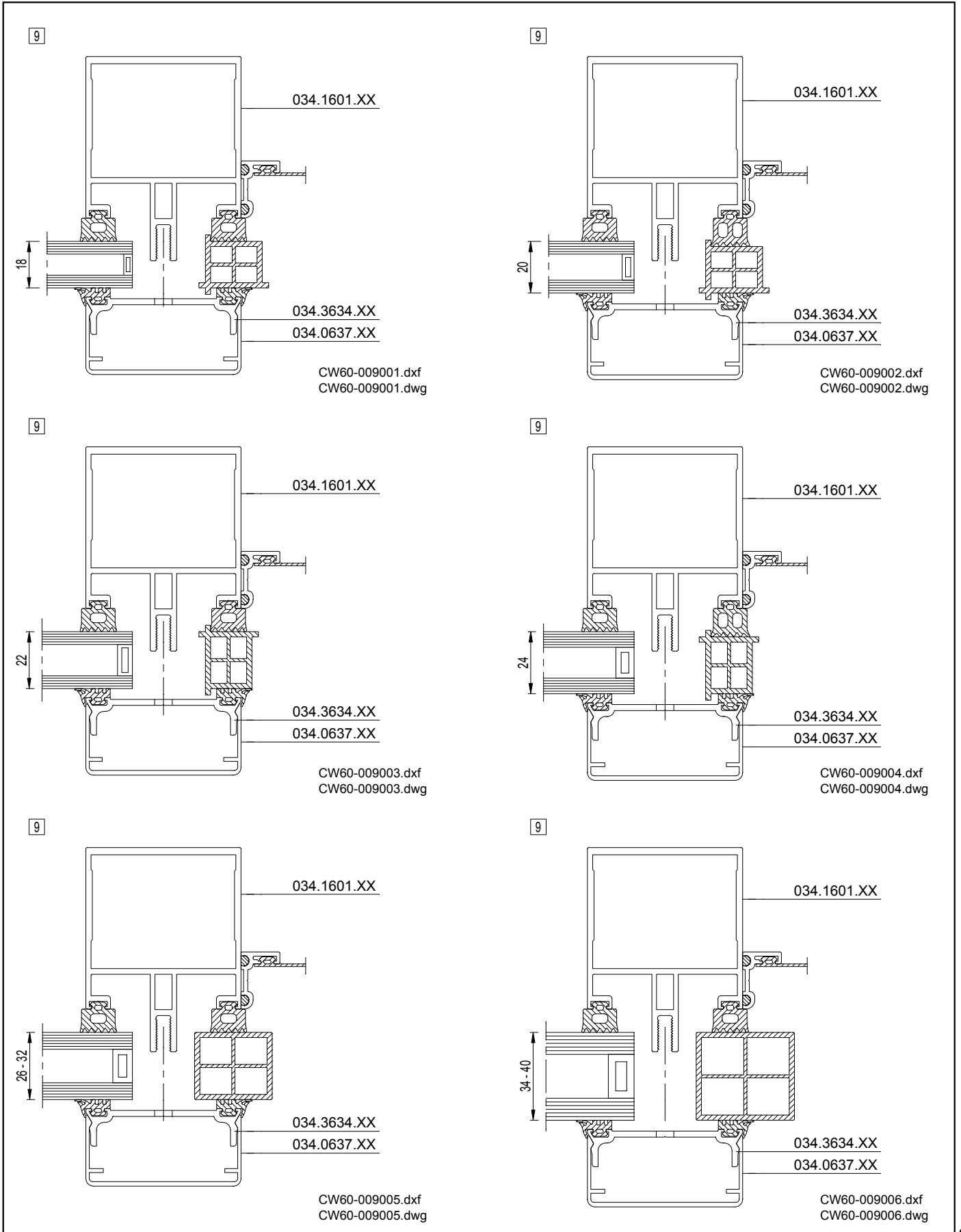
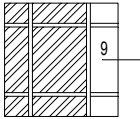

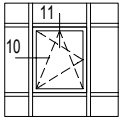

CS 68

10

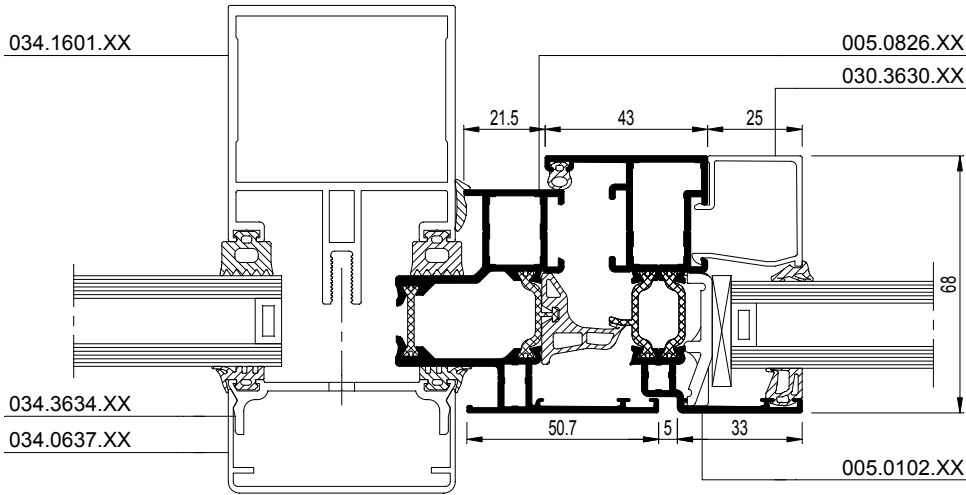

11

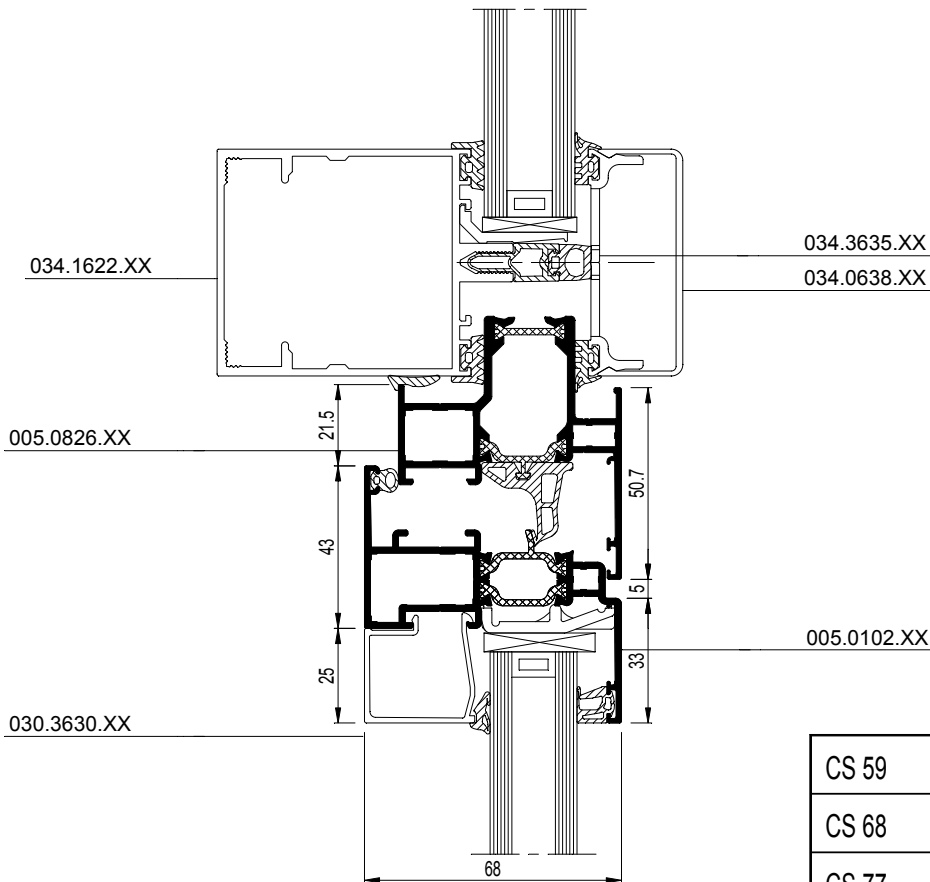

	10	11
CS 59	CW60-010001.dxf CW60-010001.dwg	CW60-011001.dxf CW60-011001.dwg
CS 68	CW60-010002.dxf CW60-010002.dwg	CW60-011002.dxf CW60-011002.dwg
CS 77	CW60-010003.dxf CW60-010003.dwg	CW60-011003.dxf CW60-011003.dwg
ECO	CW60-010005.dxf CW60-010005.dwg	CW60-011005.dxf CW60-011005.dwg
CS 86-HI	CW60-010006.dxf CW60-010006.dwg	CW60-011006.dxf CW60-011006.dwg

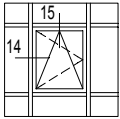

CS 68-HV

14

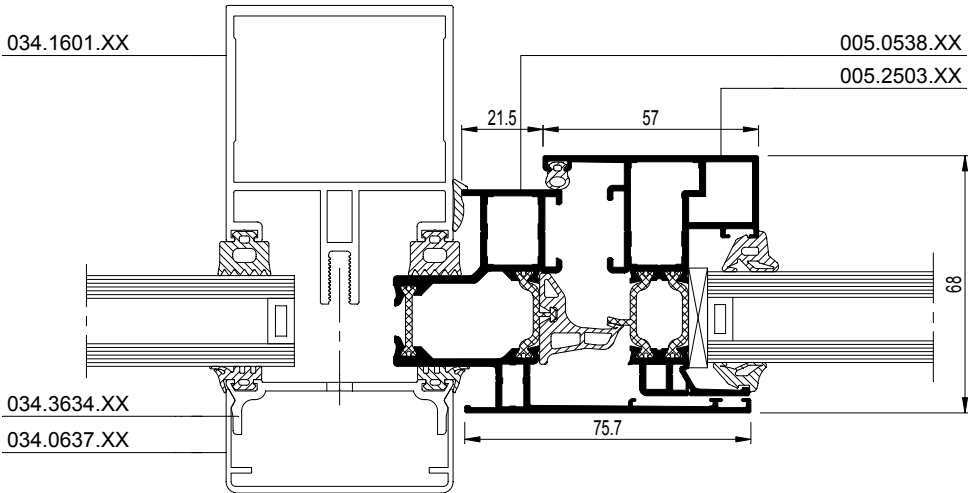

15

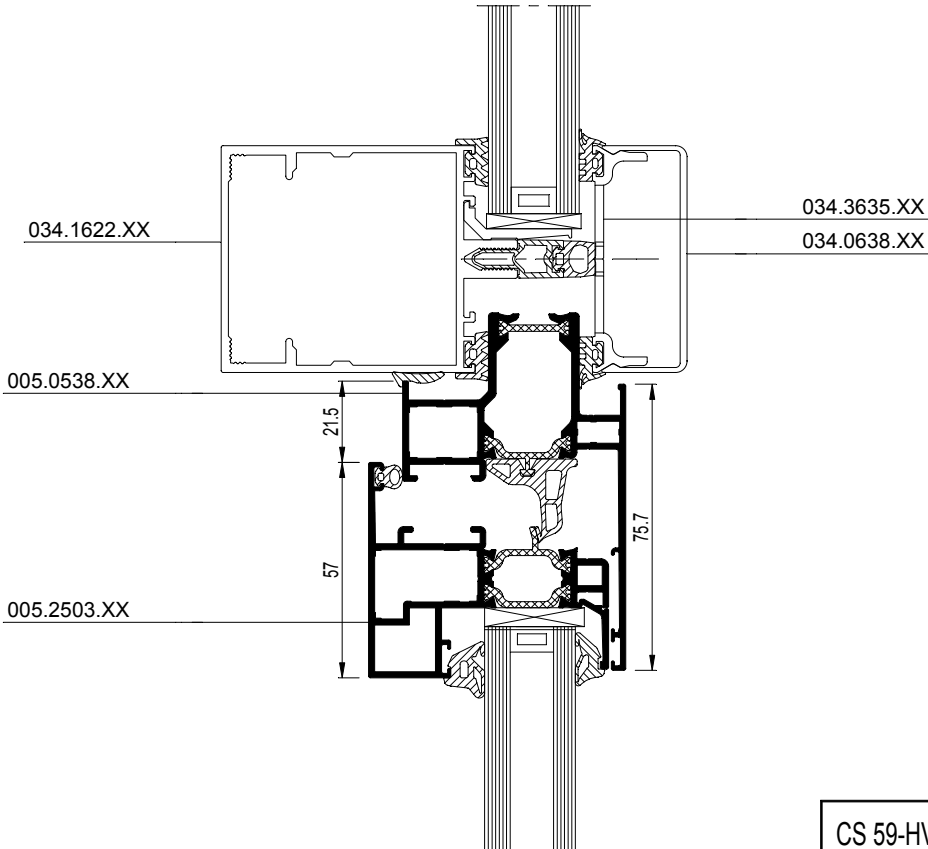

	14	15
CS 59-HV	CW60-014001.dxf CW60-014001.dwg	CW60-015001.dxf CW60-015001.dwg
CS 68-HV	CW60-014002.dxf CW60-014002.dwg	CW60-015002.dxf CW60-015002.dwg
CS 77-HV	CW60-014003.dxf CW60-014003.dwg	CW60-015003.dxf CW60-015003.dwg
CS 86-HI/HV	CW60-014004.dxf CW60-014004.dwg	CW60-015004.dxf CW60-015004.dwg

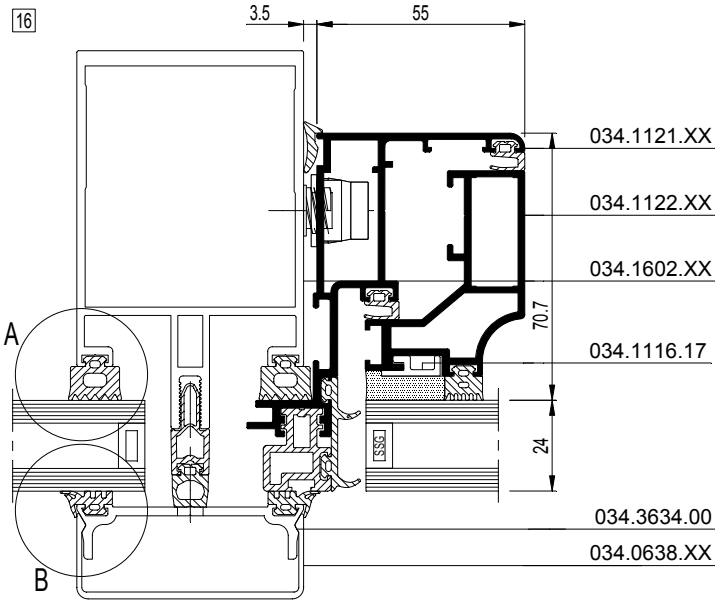
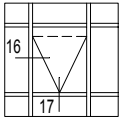

... .dxf
dwg

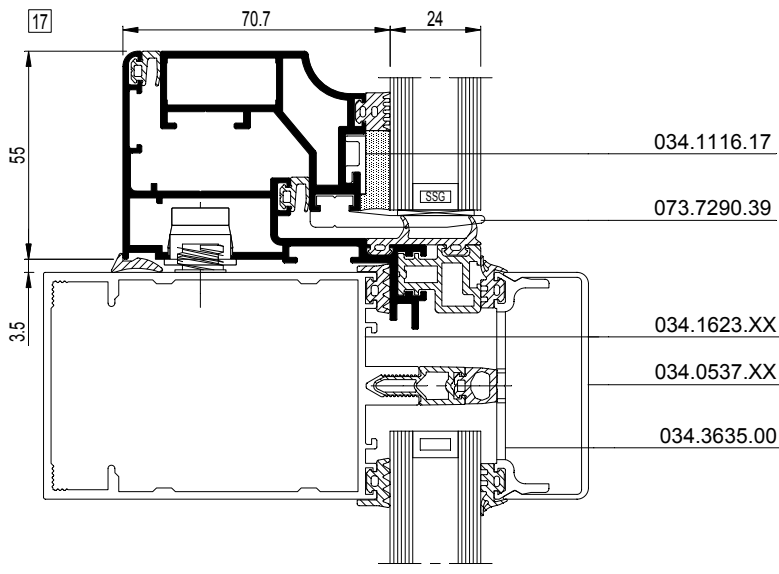

... .dxf
dwg



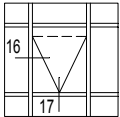

034.1121.XX + 034.1122.XX

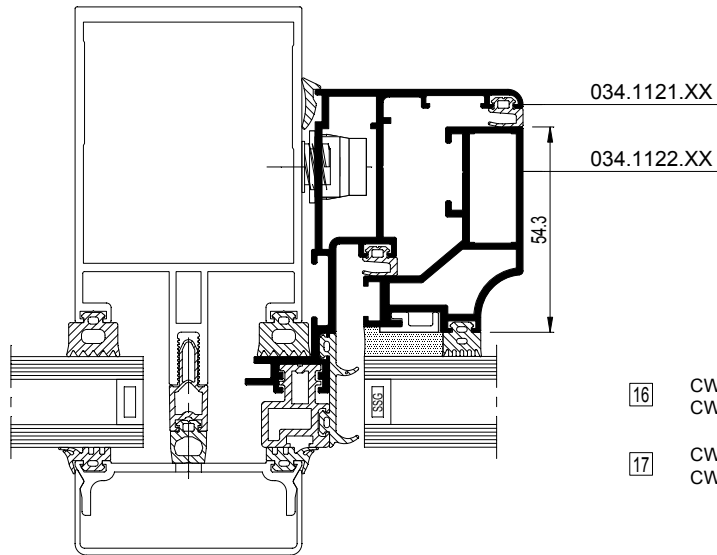

- 16 CW60-016001.dxf
CW60-016001.dwg
- 17 CW60-017001.dxf
CW60-017001.dwg

034.0155.XX + 034.0156.XX

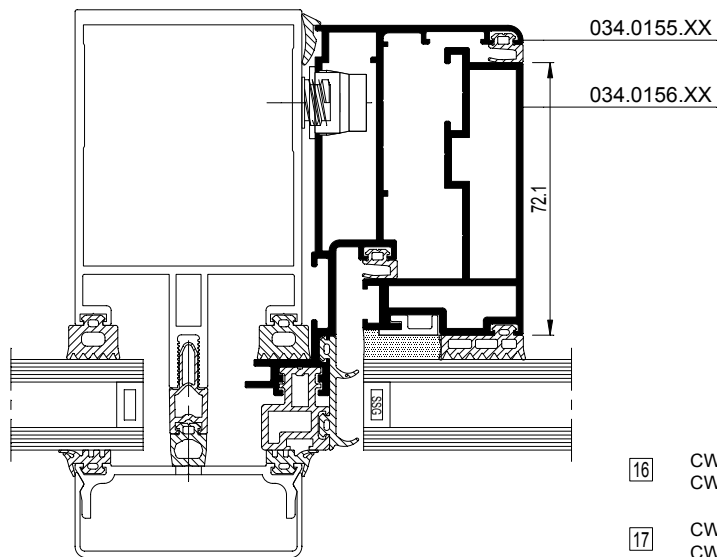

- 16 CW60-016004.dxf
CW60-016004.dwg
- 17 CW60-017002.dxf
CW60-017002.dwg

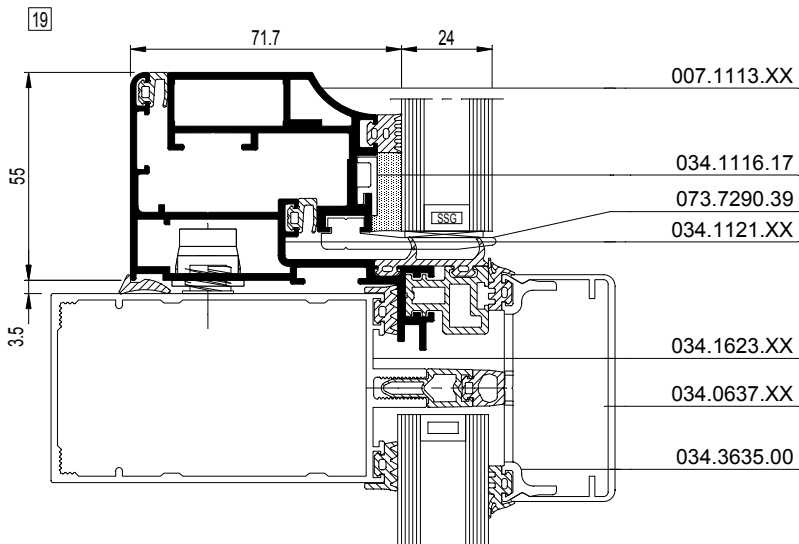
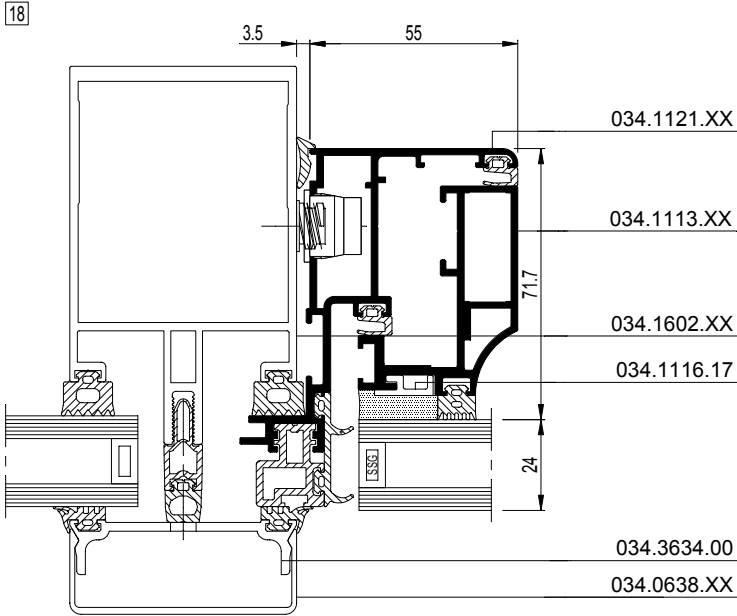
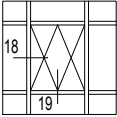

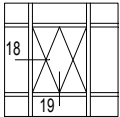

034.1121.XX + 034.1113.XX

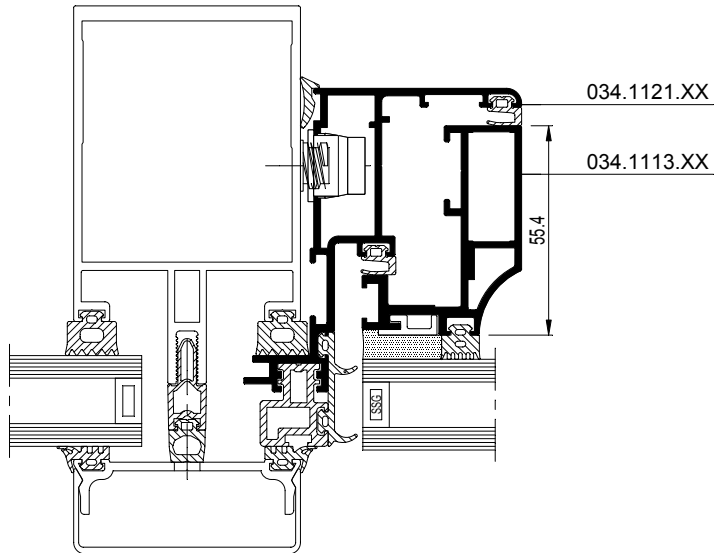

- 18 CW60-018001.dxf
CW60-018001.dwg
- 19 CW60-019001.dxf
CW60-019001.dwg

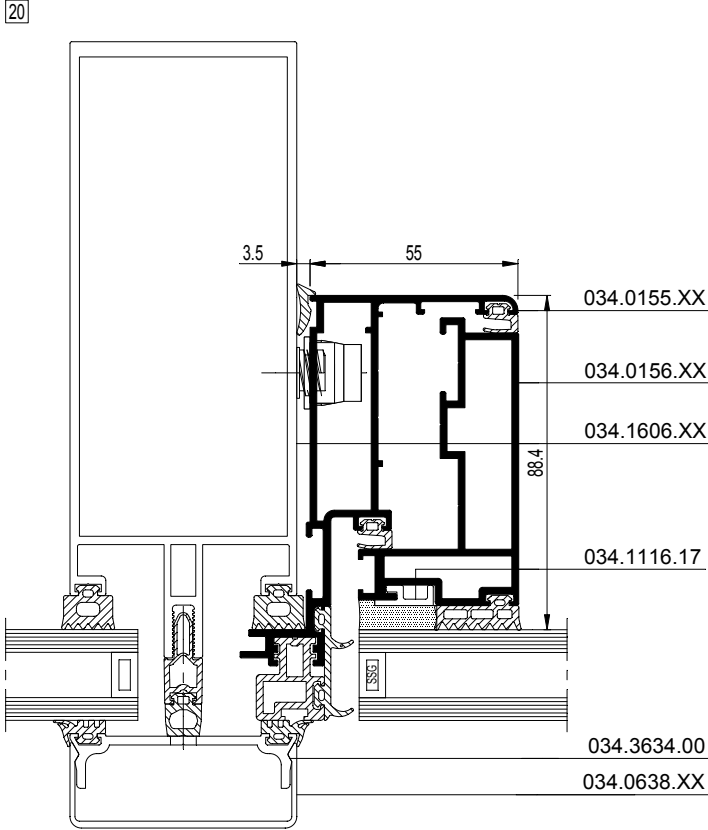
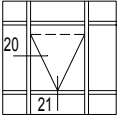

CW60-020001.dxf
 CW60-020001.dwg

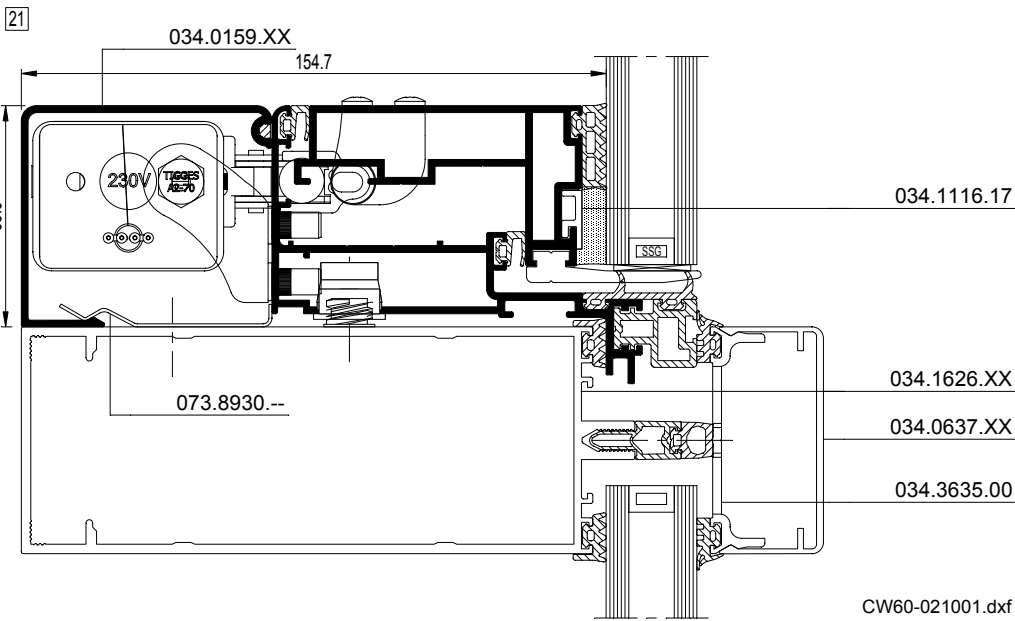

CW60-021001.dxf
 CW60-021001.dwg



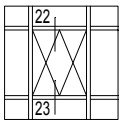

22

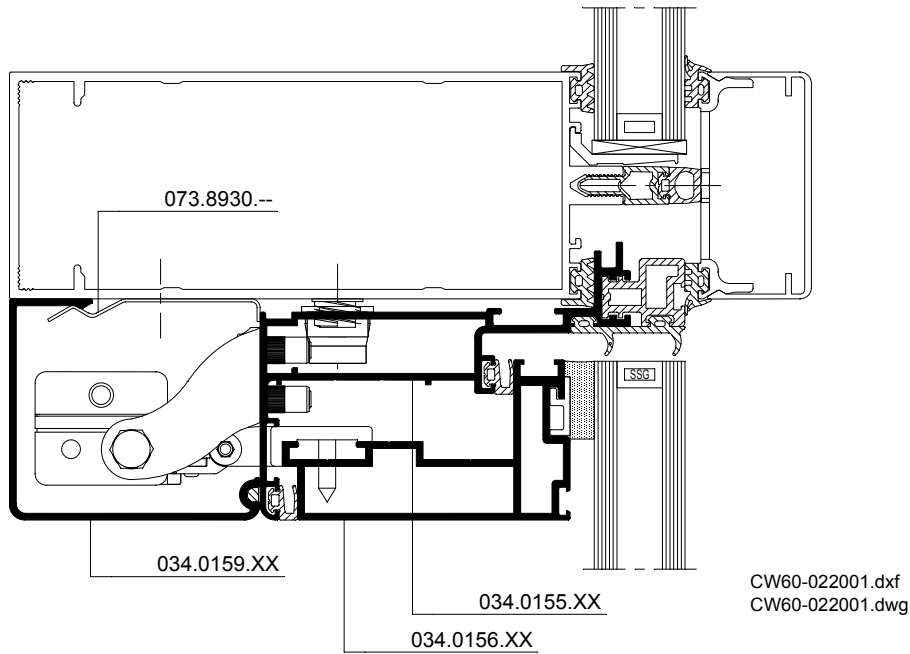

23

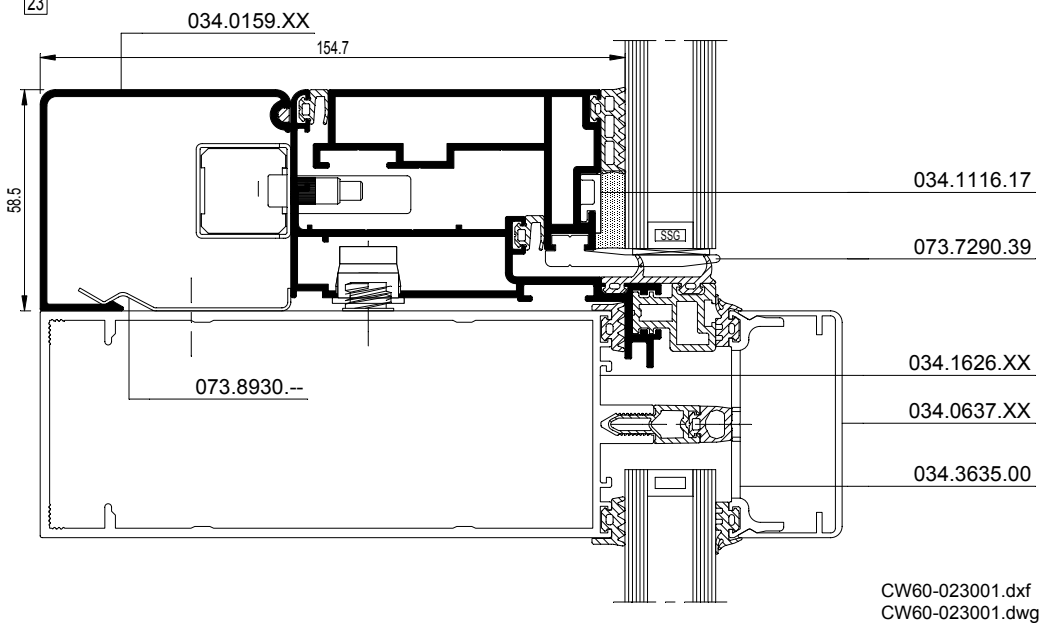

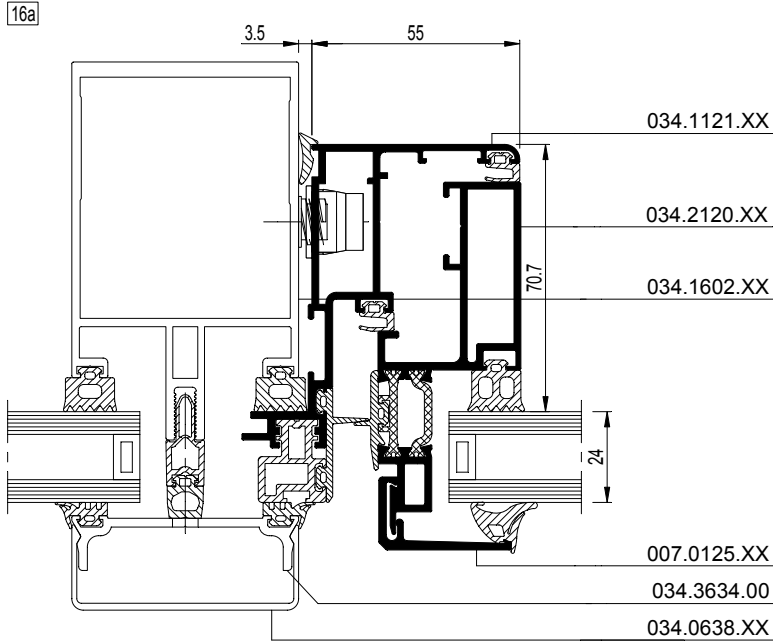
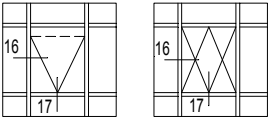

... .dxf
dwg

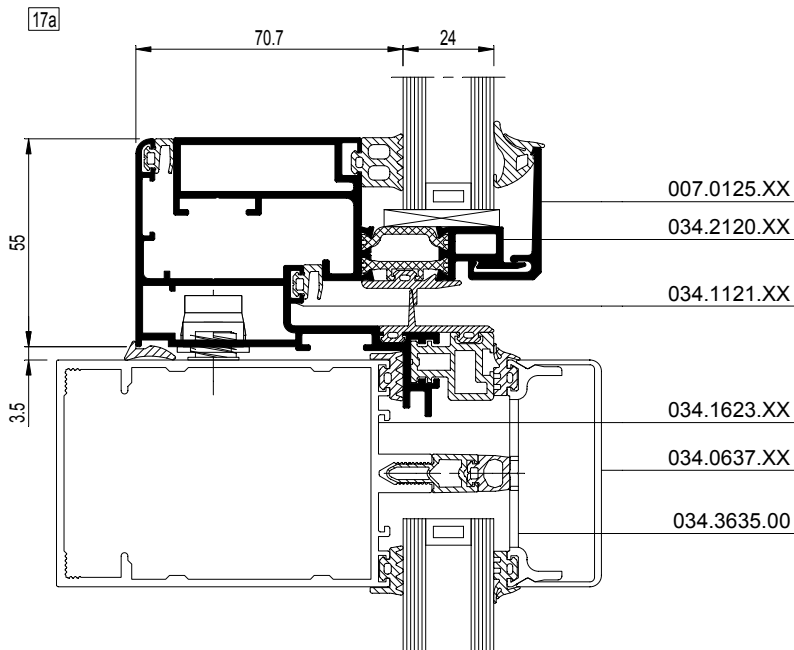

... .dxf
dwg



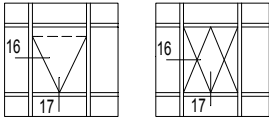

034.1121.XX + 034.2120.XX

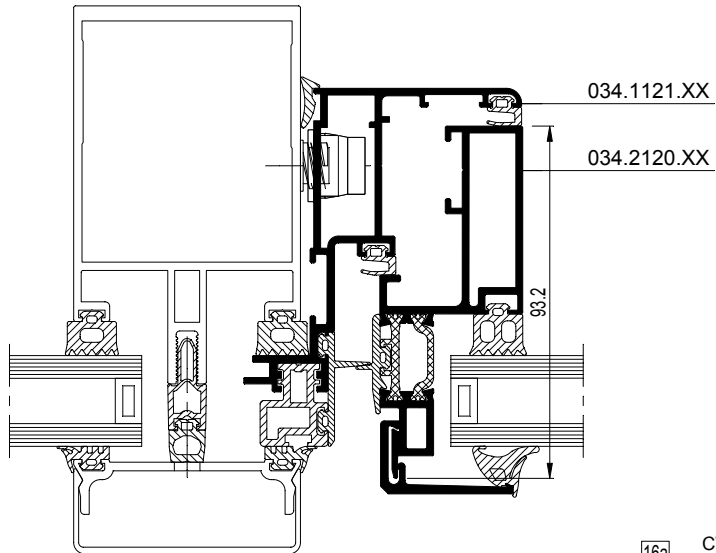

16a CW60-016007.dxf
 CW60-016007.dwg

17a CW60-017003.dxf
 CW60-017003.dwg

034.0155.XX + 034.0157.XX

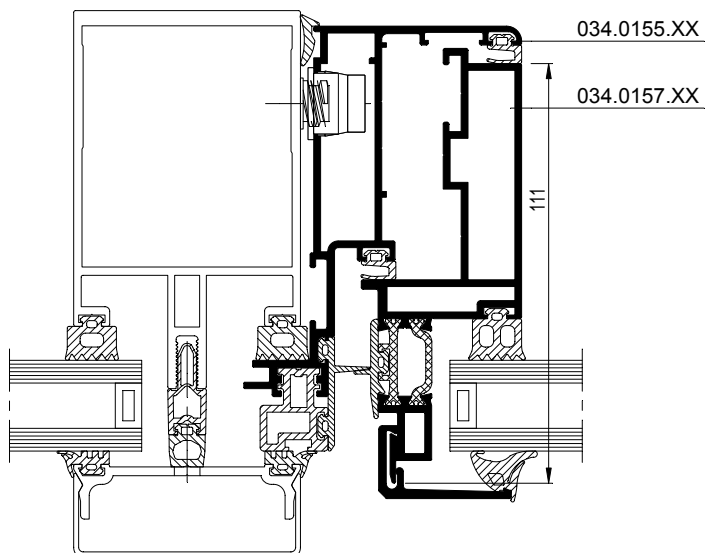

16a CW60-016010.dxf
 CW60-016010.dwg

17a CW60-017004.dxf
 CW60-017004.dwg

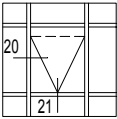

20a

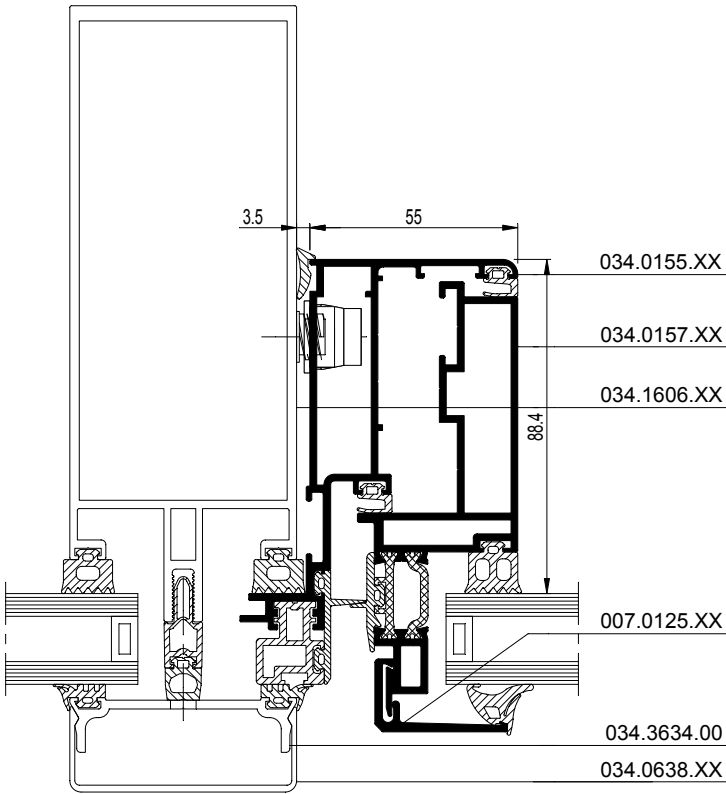

CW60-020002.dxf
 CW60-020002.dwg

31a

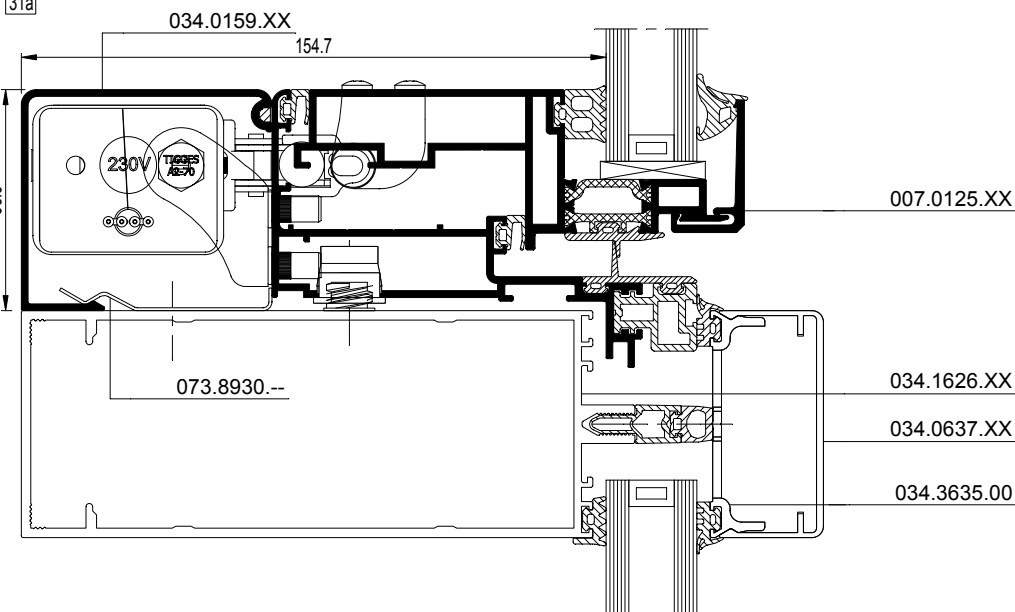

CW60-021002.dxf
 CW60-021002.dwg

22	
23	

22a

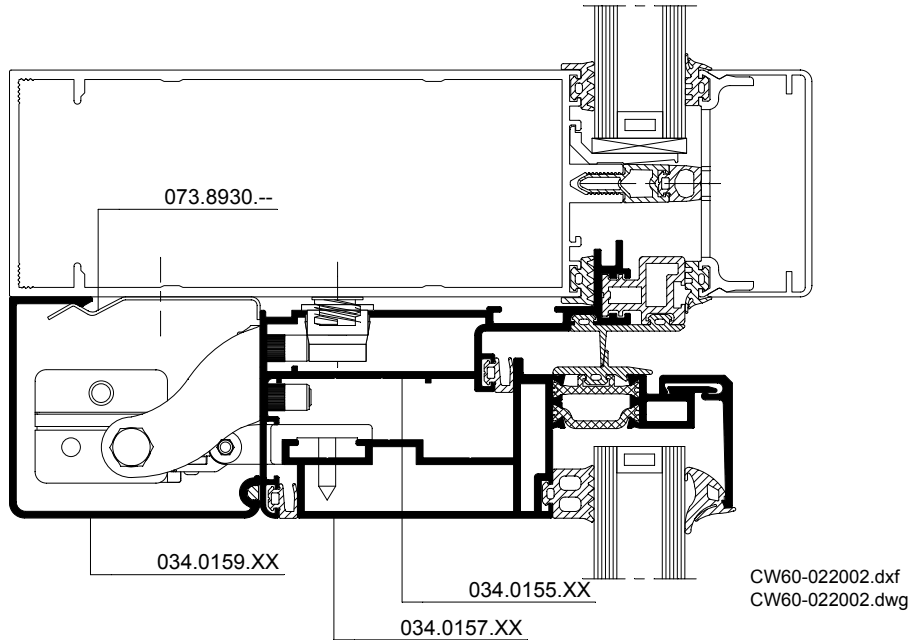

23a

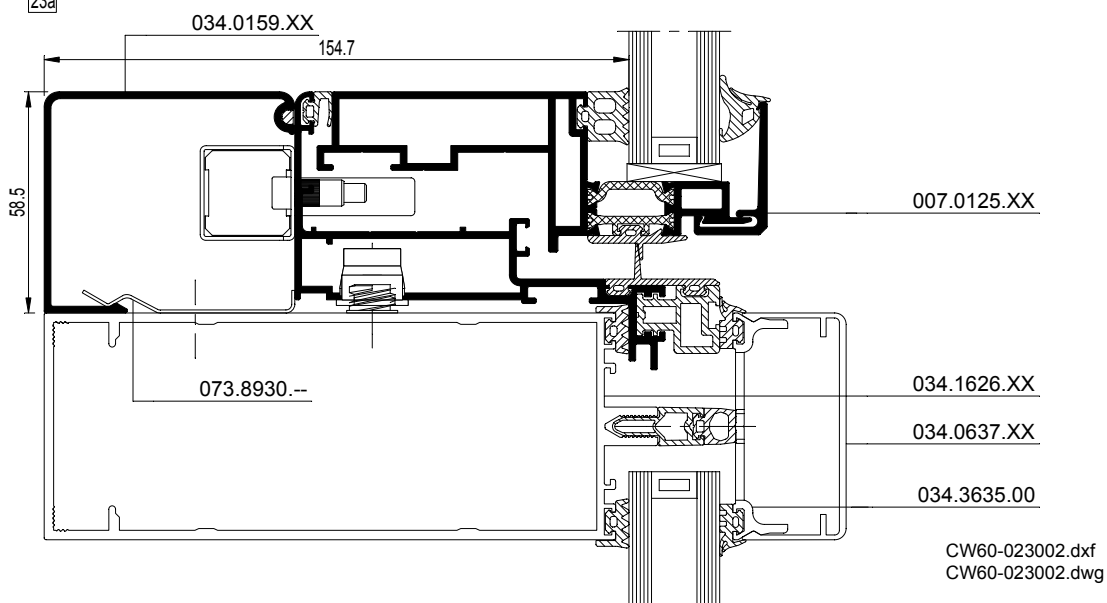

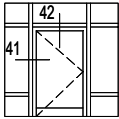

CS 68

41

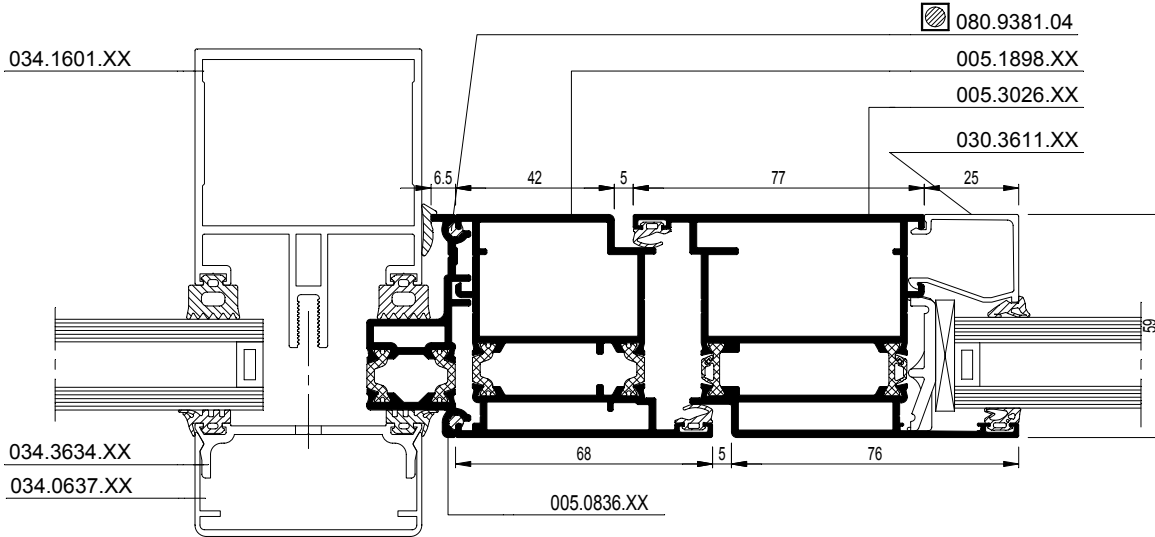

42

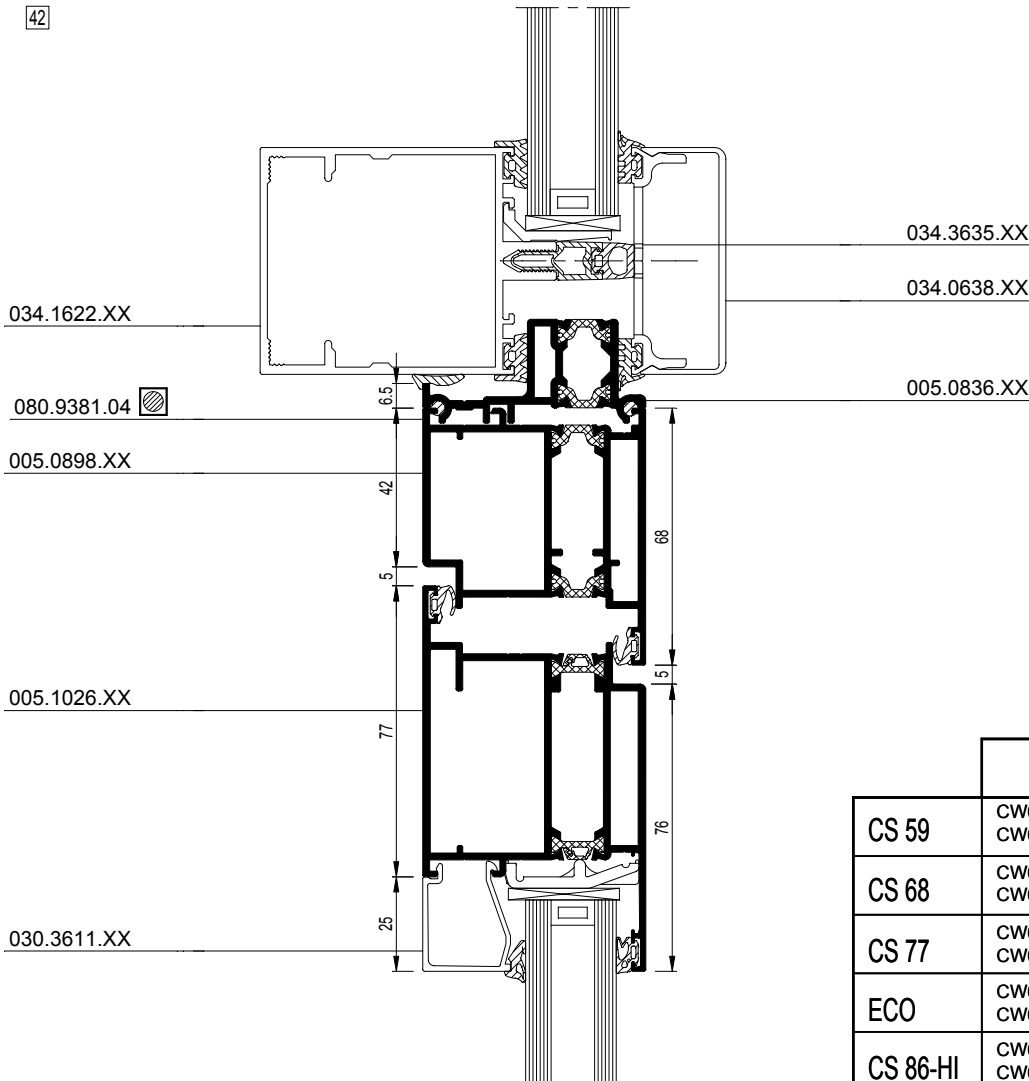

	41	42
CS 59	CW60-041001.dxf CW60-041001.dwg	CW60-042001.dxf CW60-042001.dwg
CS 68	CW60-041002.dxf CW60-041002.dwg	CW60-042002.dxf CW60-042002.dwg
CS 77	CW60-041003.dxf CW60-041003.dwg	CW60-042003.dxf CW60-042003.dwg
ECO	CW60-041004.dxf CW60-041004.dwg	CW60-042004.dxf CW60-042004.dwg
CS 86-HI	CW60-041005.dxf CW60-041005.dwg	CW60-042005.dxf CW60-042005.dwg

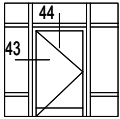

CS 68

43

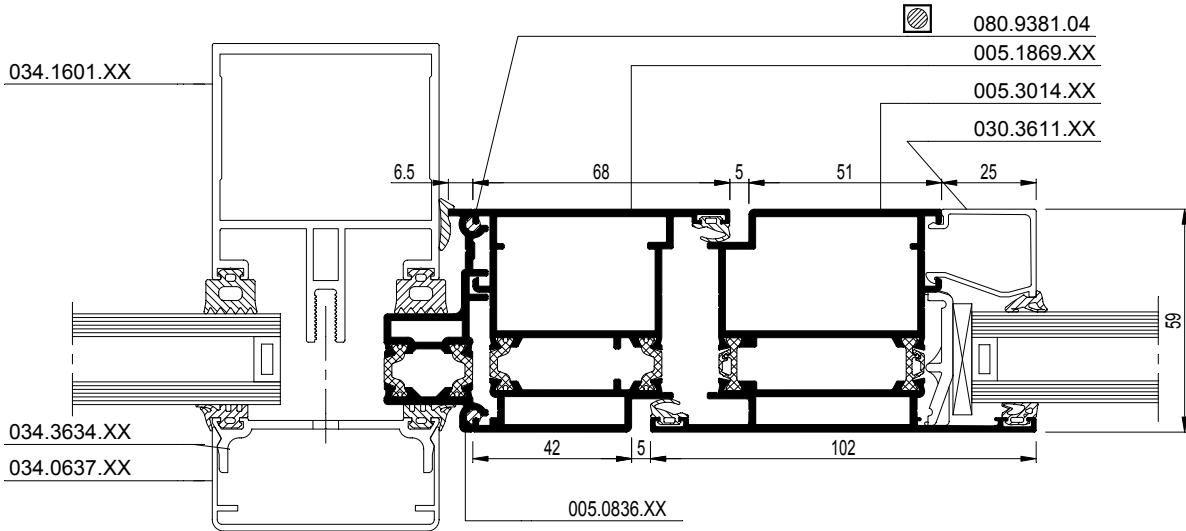

44

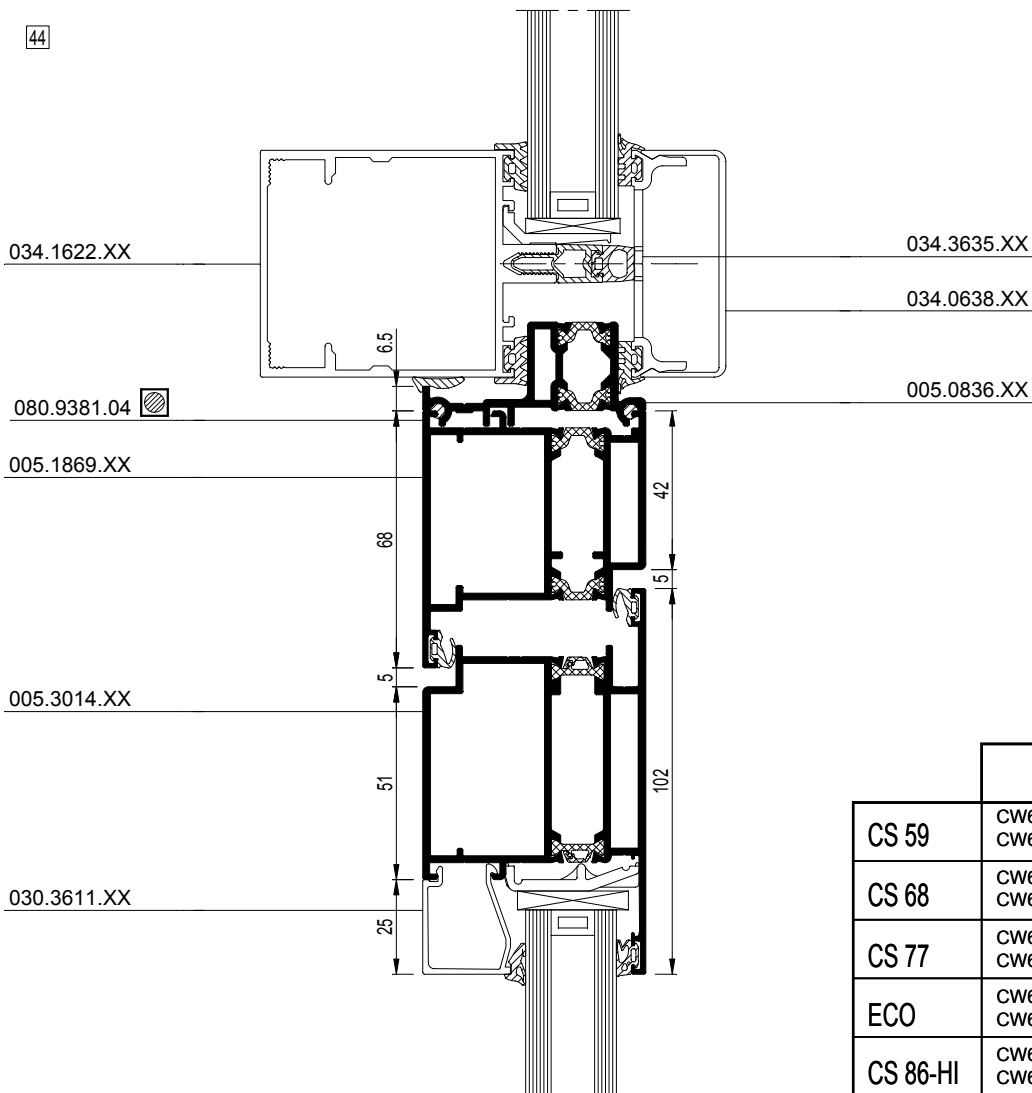

	43	44
CS 59	CW60-043001.dxf CW60-043001.dwg	CW60-044001.dxf CW60-044001.dwg
CS 68	CW60-043002.dxf CW60-043002.dwg	CW60-044002.dxf CW60-044002.dwg
CS 77	CW60-043003.dxf CW60-043003.dwg	CW60-044003.dxf CW60-044003.dwg
ECO	CW60-043004.dxf CW60-043004.dwg	CW60-044004.dxf CW60-044004.dwg
CS 86-HI	CW60-043005.dxf CW60-043005.dwg	CW60-044005.dxf CW60-044005.dwg

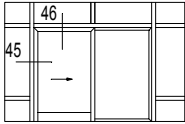

CP 130

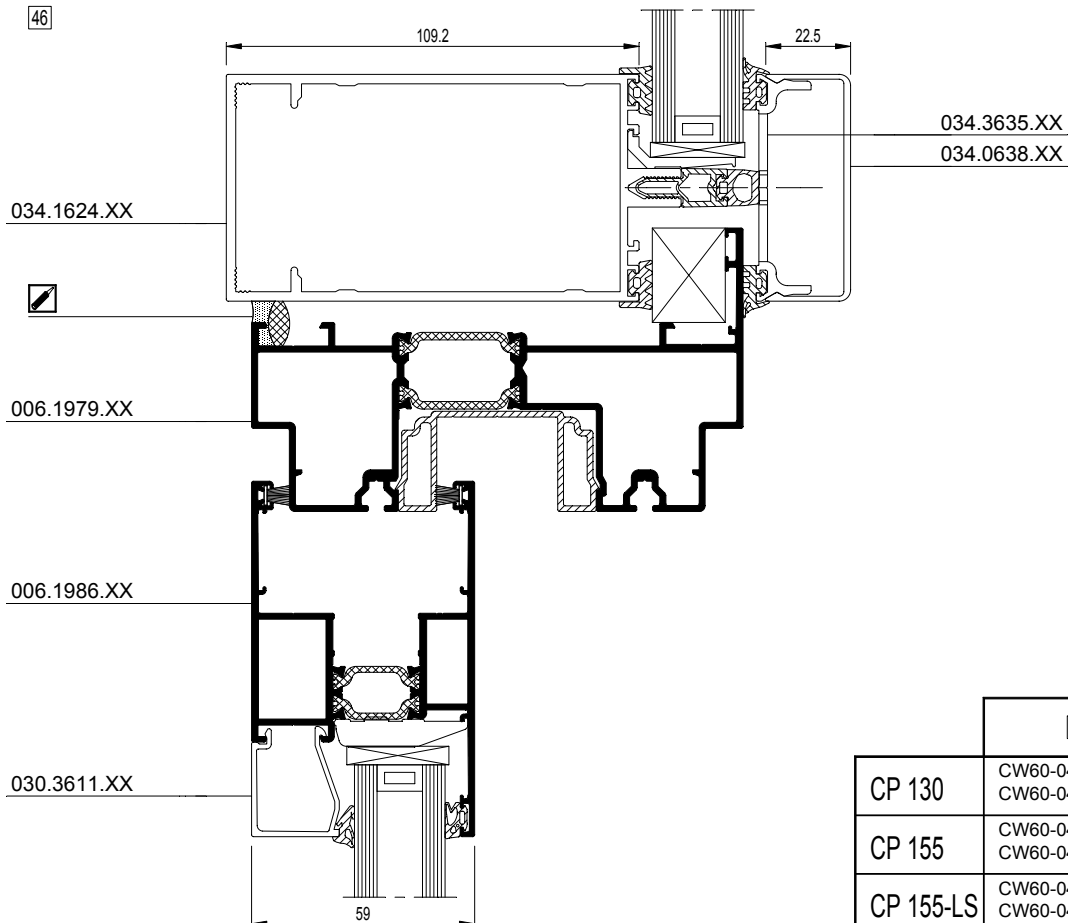
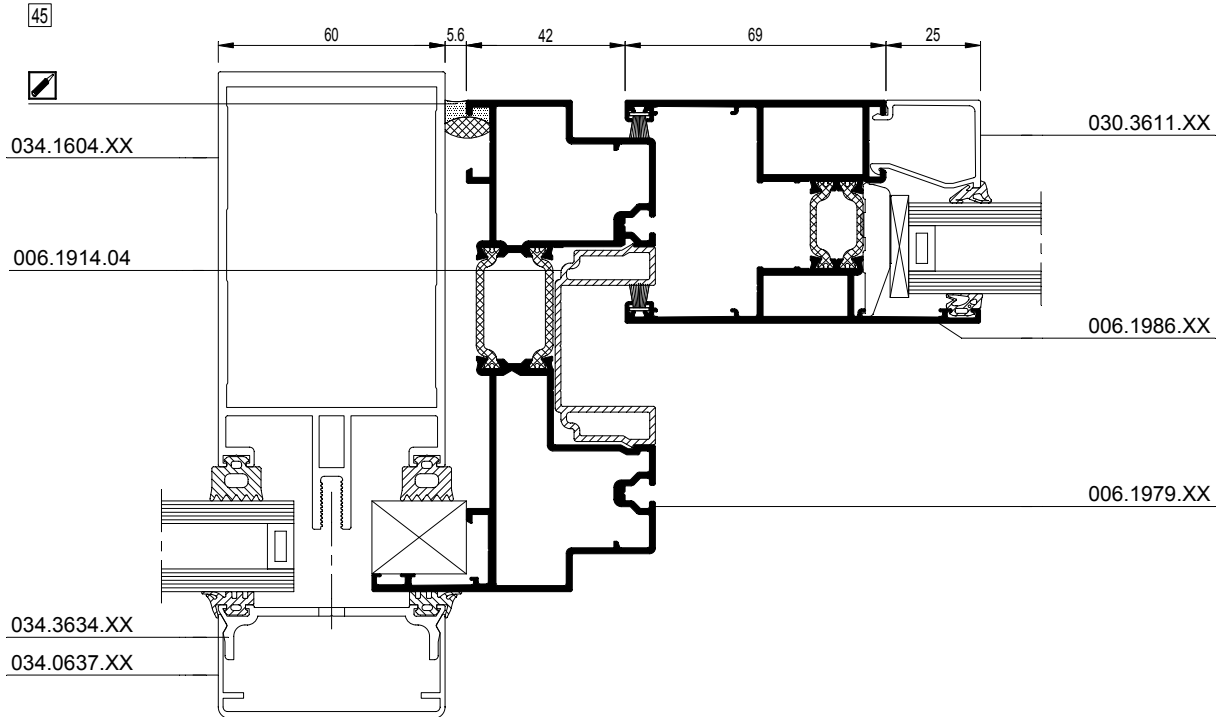

	45	46
CP 130	CW60-045001.dxf CW60-045001.dwg	CW60-046001.dxf CW60-046001.dwg
CP 155	CW60-045002.dxf CW60-045002.dwg	CW60-046002.dxf CW60-046002.dwg
CP 155-LS	CW60-045003.dxf CW60-045003.dwg	CW60-046003.dxf CW60-046003.dwg

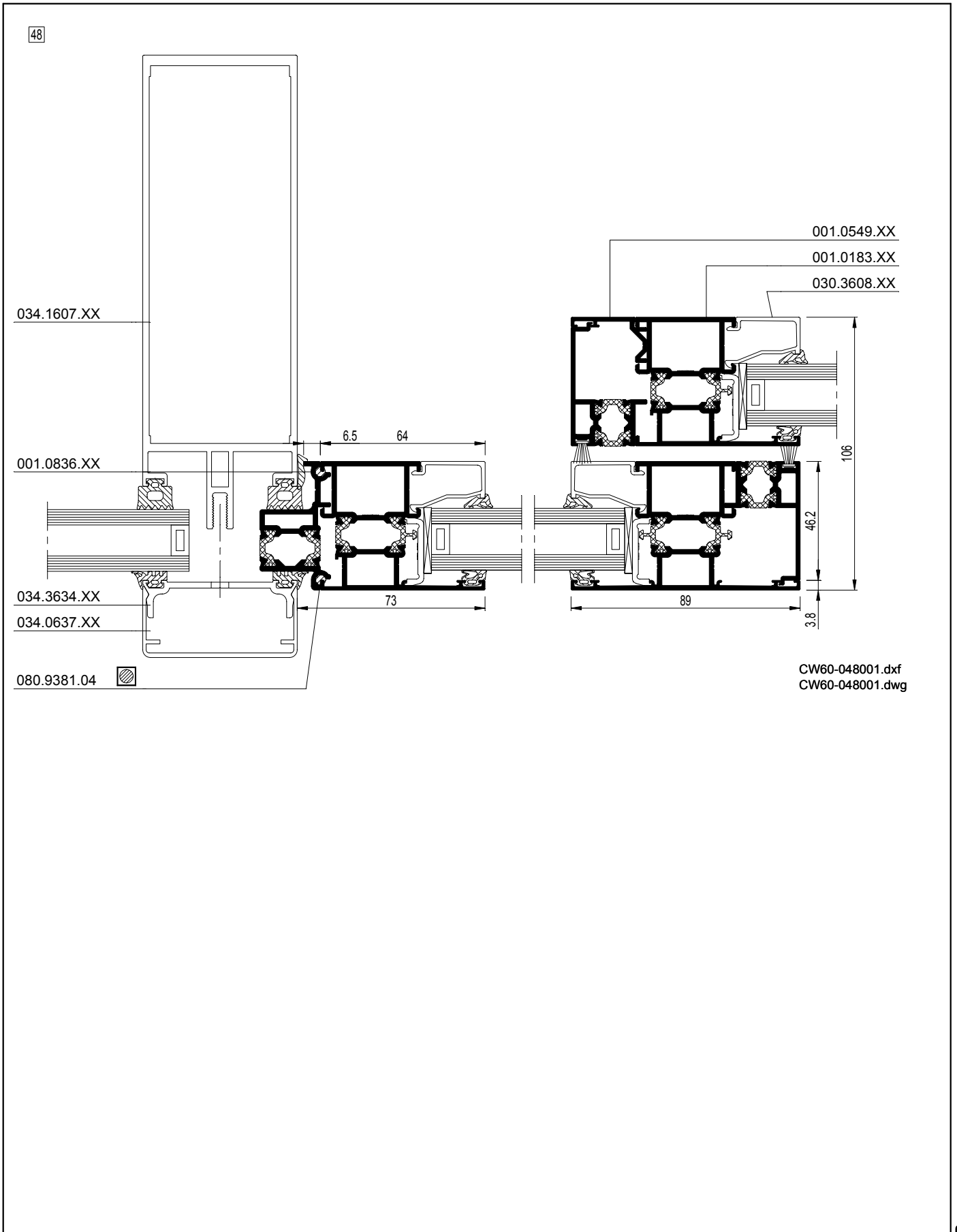
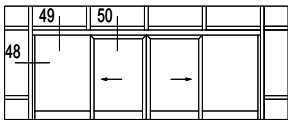

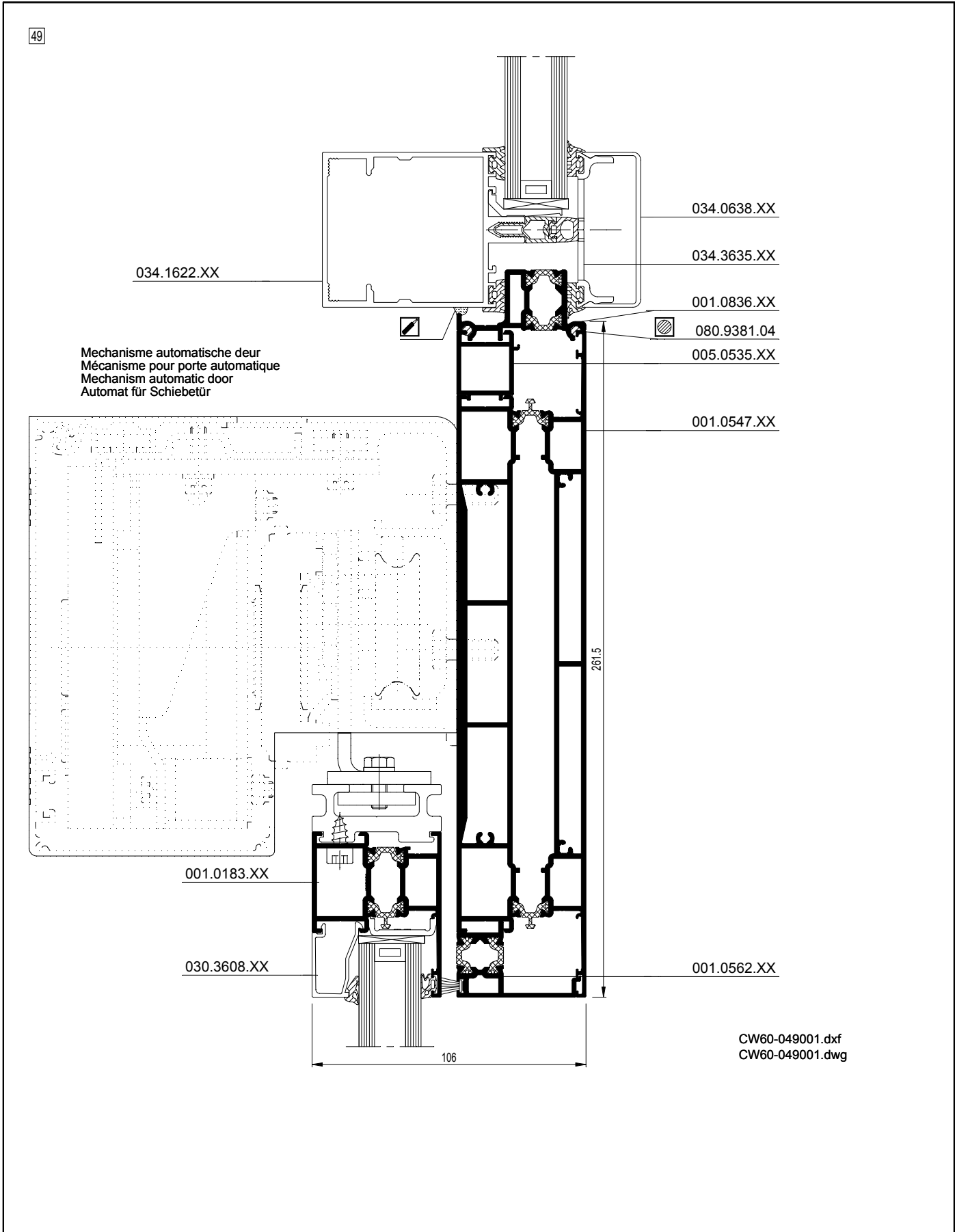
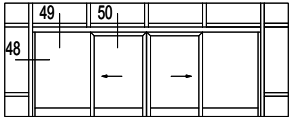

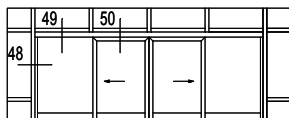

50

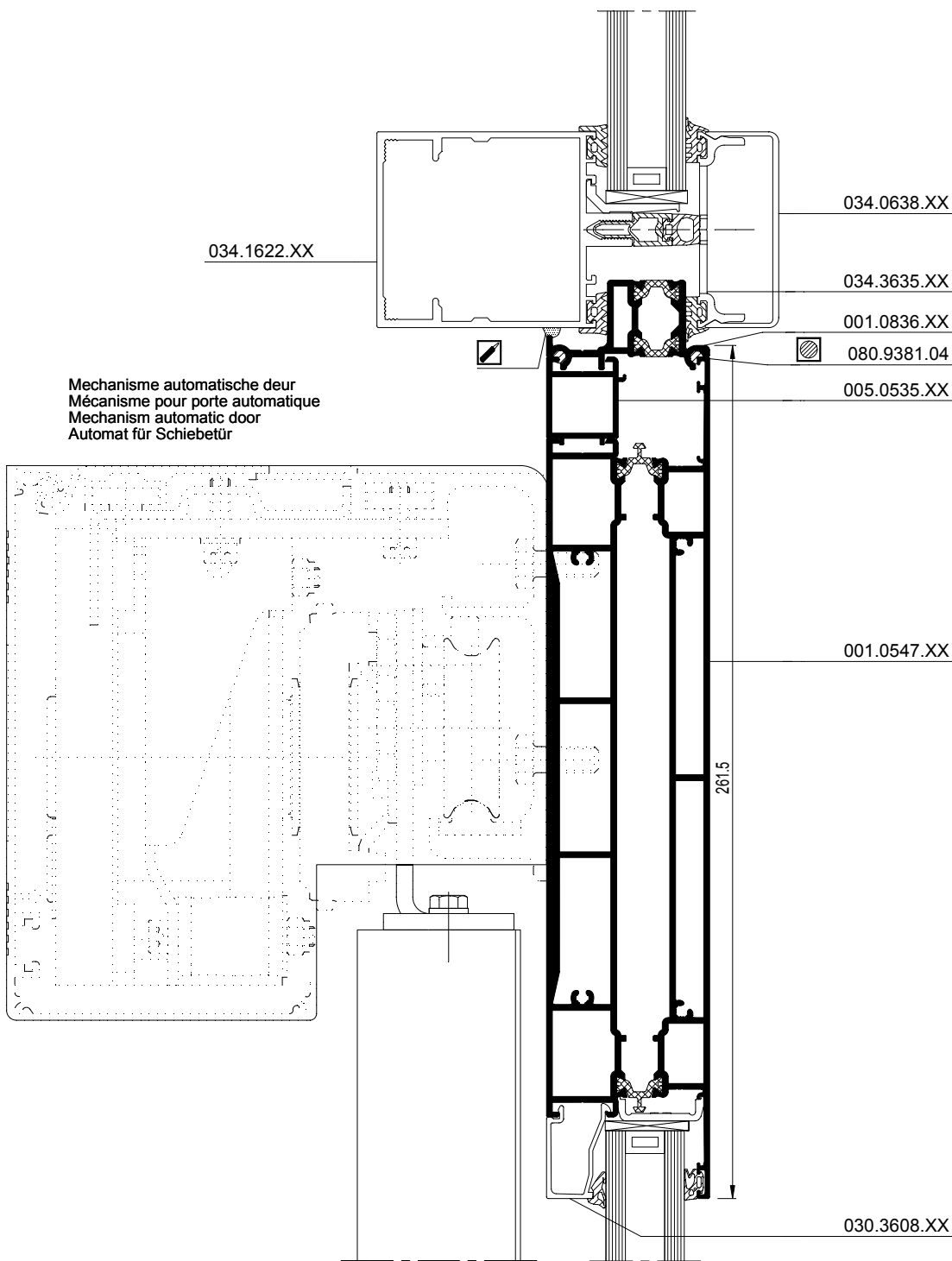

Mechanisme automatische deur
 Mécanisme pour porte automatique
 Mechanism automatic door
 Automat für Schiebetür

CW60-050001.dxf
 CW60-050001.dwg

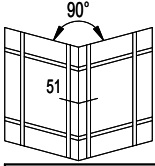

51

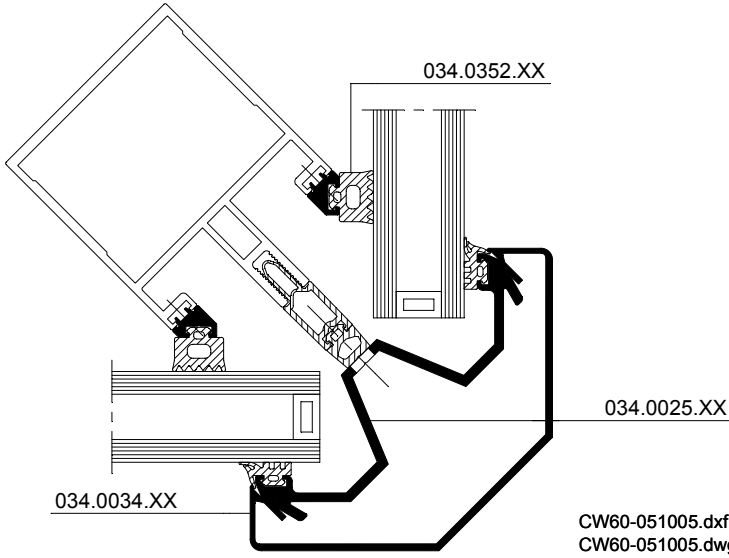

51

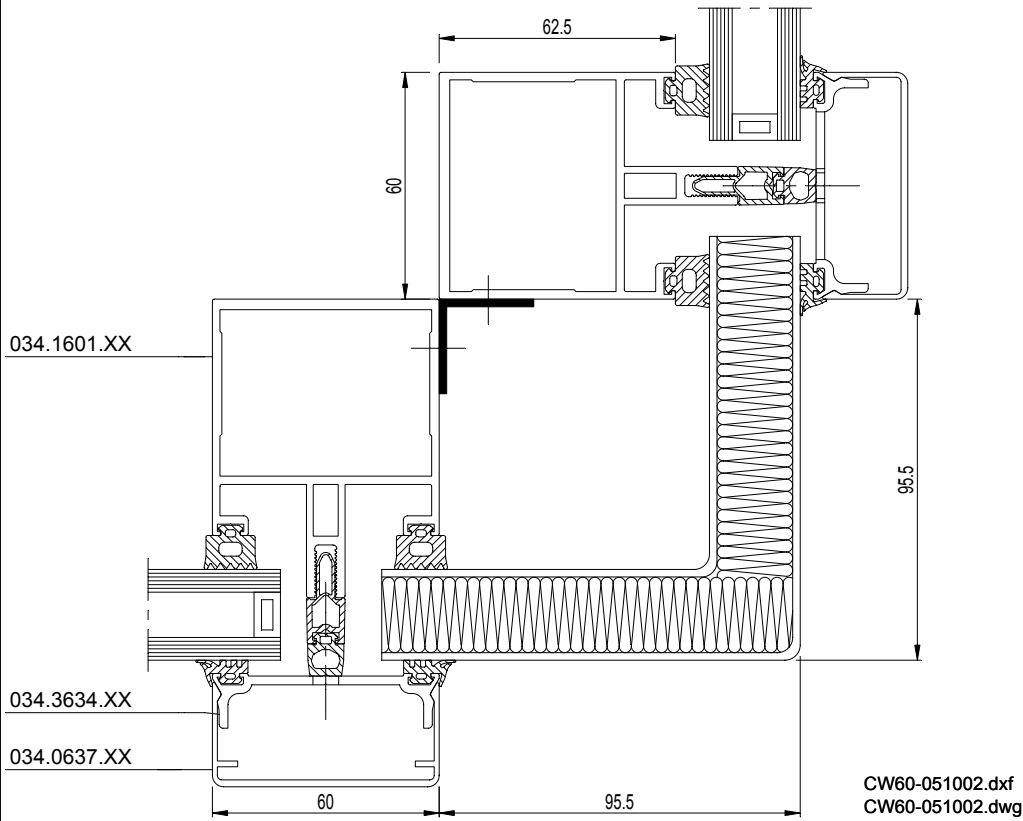

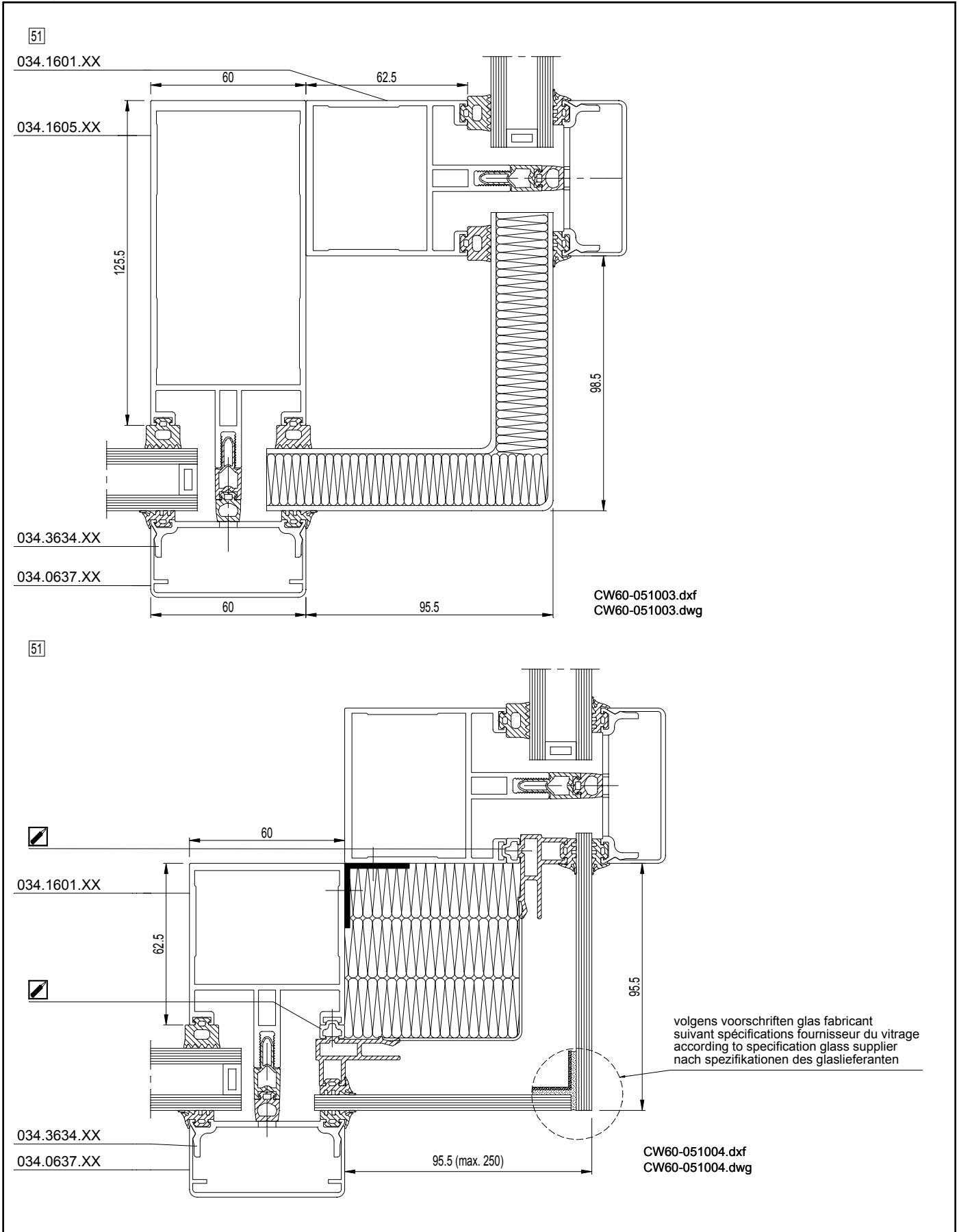
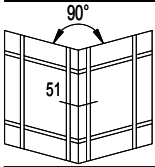

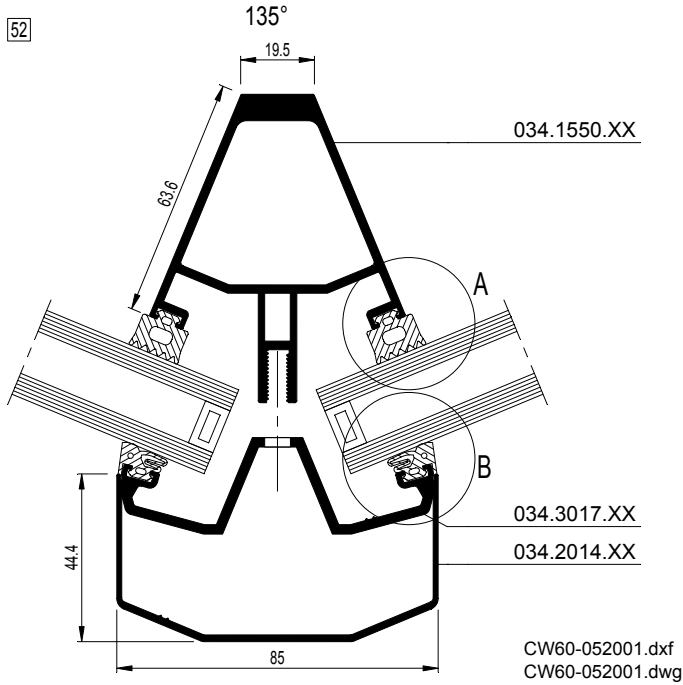
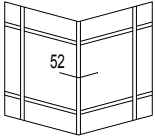

MIN. 105°

MAX. 155°

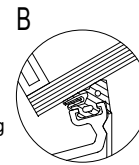
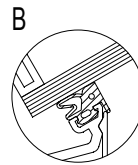
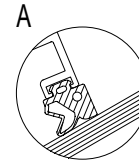
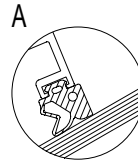

CW60-052002.dxf
CW60-052002.dwg

CW60-052003.dxf
CW60-052003.dwg

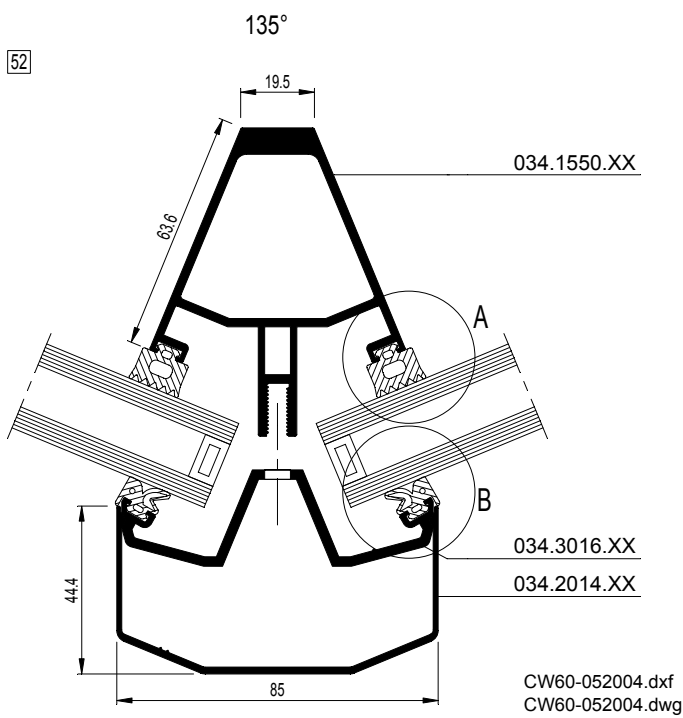

MIN. 105°

MAX. 140°

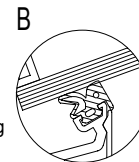
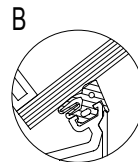
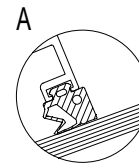
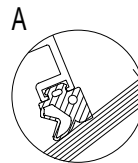

CW60-052005.dxf
CW60-052005.dwg

CW60-052006.dxf
CW60-052006.dwg

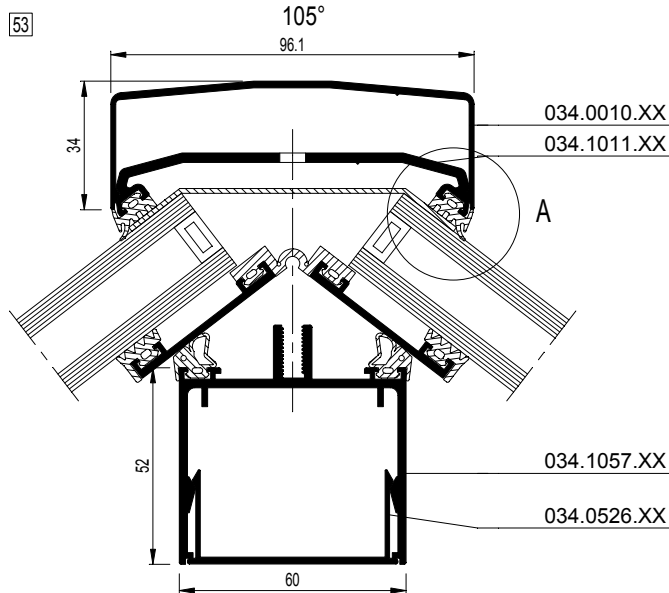
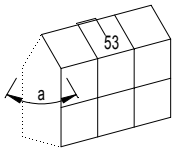

90° - 135°

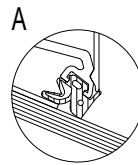

CW60-053002.dxf
 CW60-053002.dwg

CW60-053001.dxf
 CW60-053001.dwg

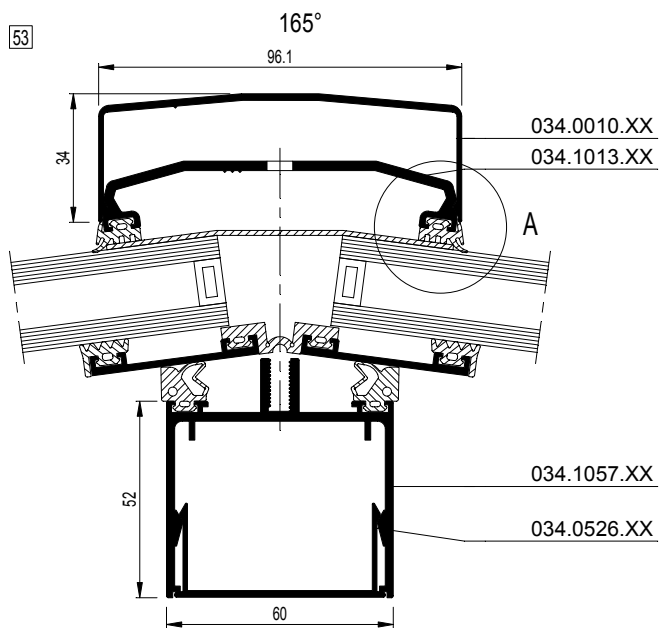

135° - 170°

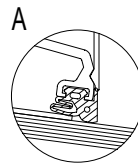

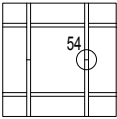

CW60-053004.dxf
 CW60-053004.dwg

CW60-053003.dxf
 CW60-053003.dwg

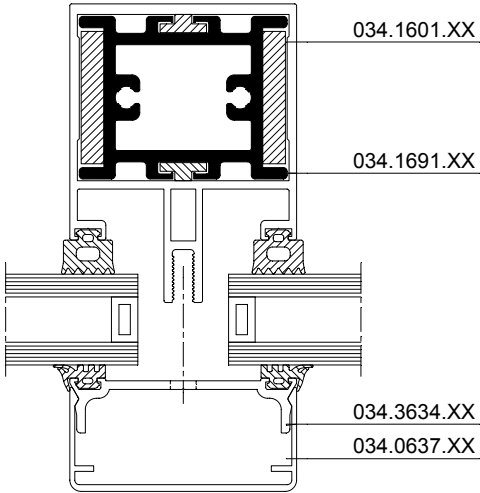

54



dxf
... .dwg

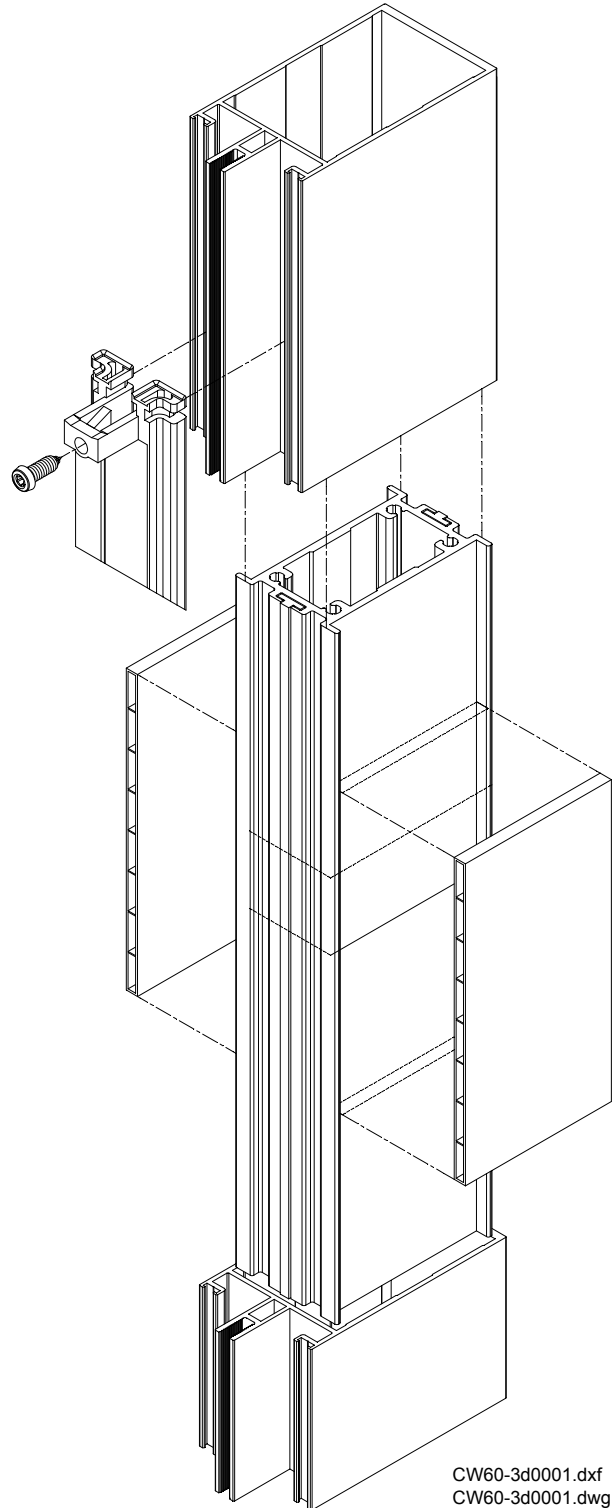

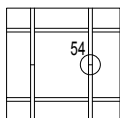

034.1691.XX

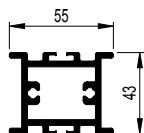

CW60-054001.dxf
 CW60-054001.dwg

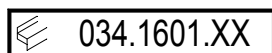

034.1692.XX

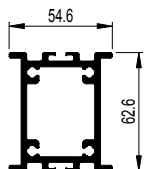

CW60-054002.dxf
 CW60-054002.dwg

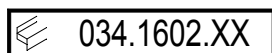

034.1693.XX

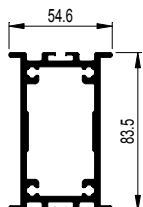

CW60-054003.dxf
 CW60-054003.dwg

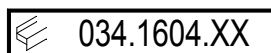

034.1694.XX

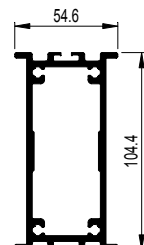

CW60-054004.dxf
 CW60-054004.dwg

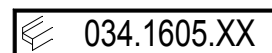

034.1695.XX

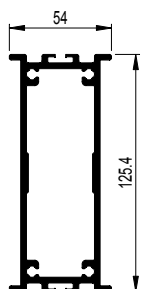

CW60-054005.dxf
 CW60-054005.dwg

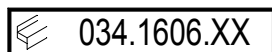

034.1696.XX

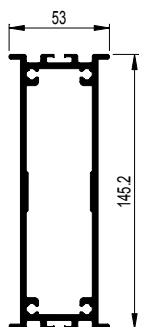

CW60-054006.dxf
 CW60-054006.dwg

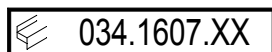

034.1697.XX

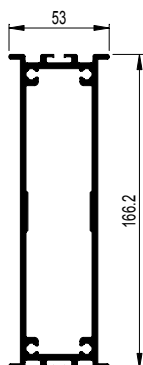

CW60-054007.dxf
 CW60-054007.dwg

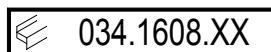

034.1699.XX

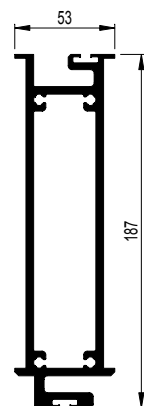

CW60-054008.dxf
 CW60-054008.dwg

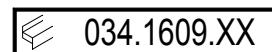

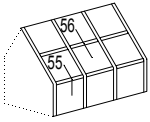

55

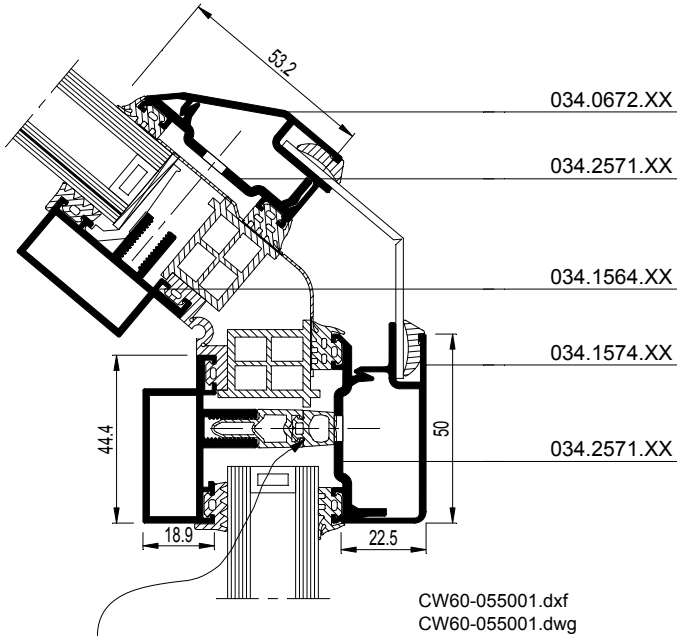

Horizontale compartimentering is verplicht
 Compartimentation horizontale est obligatoire
 Horizontal compartmentalisation is obligatory
 Horizontale Kompartimentierung ist verpflichtet

55

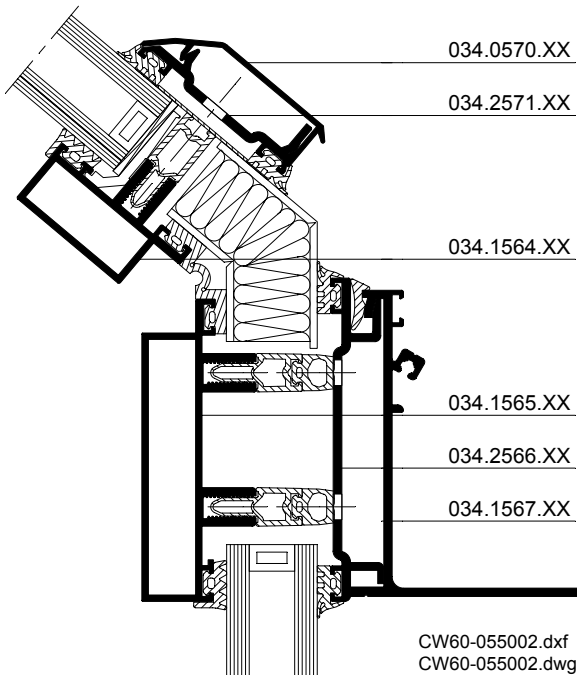

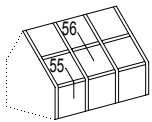

56

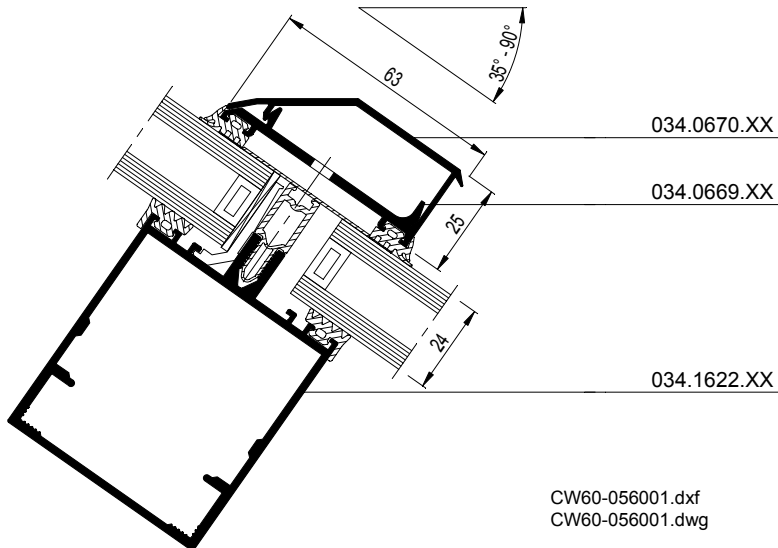

56

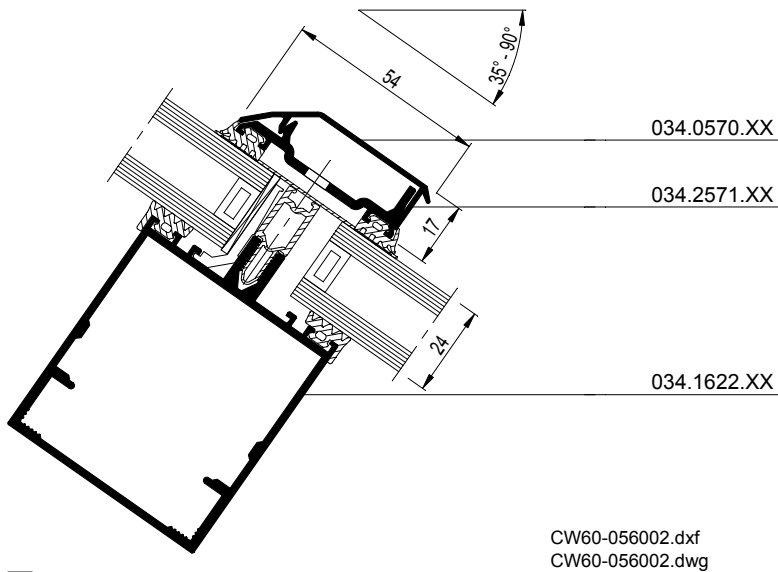

56

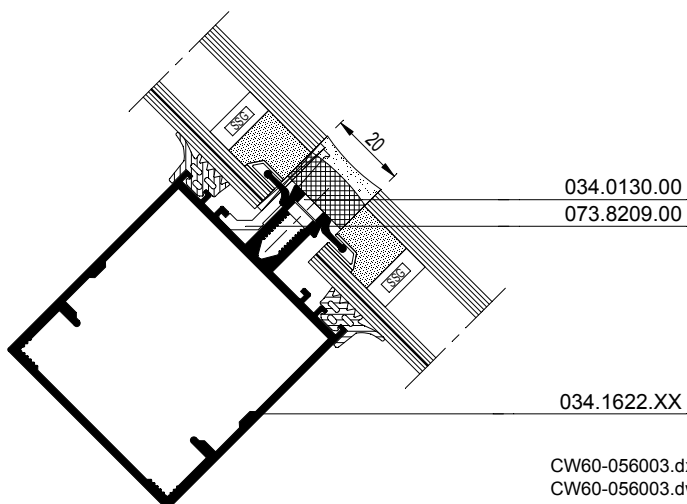

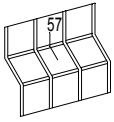

57

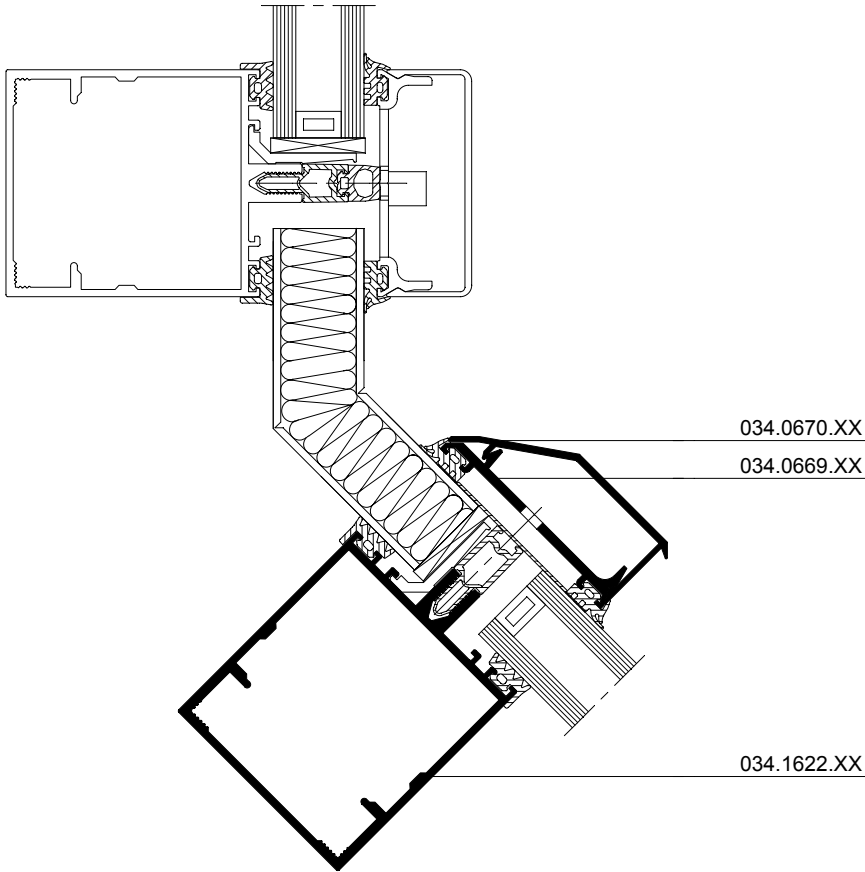

CW60-057001.dxf
CW60-057001.dwg

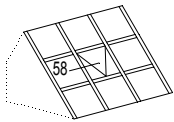

58

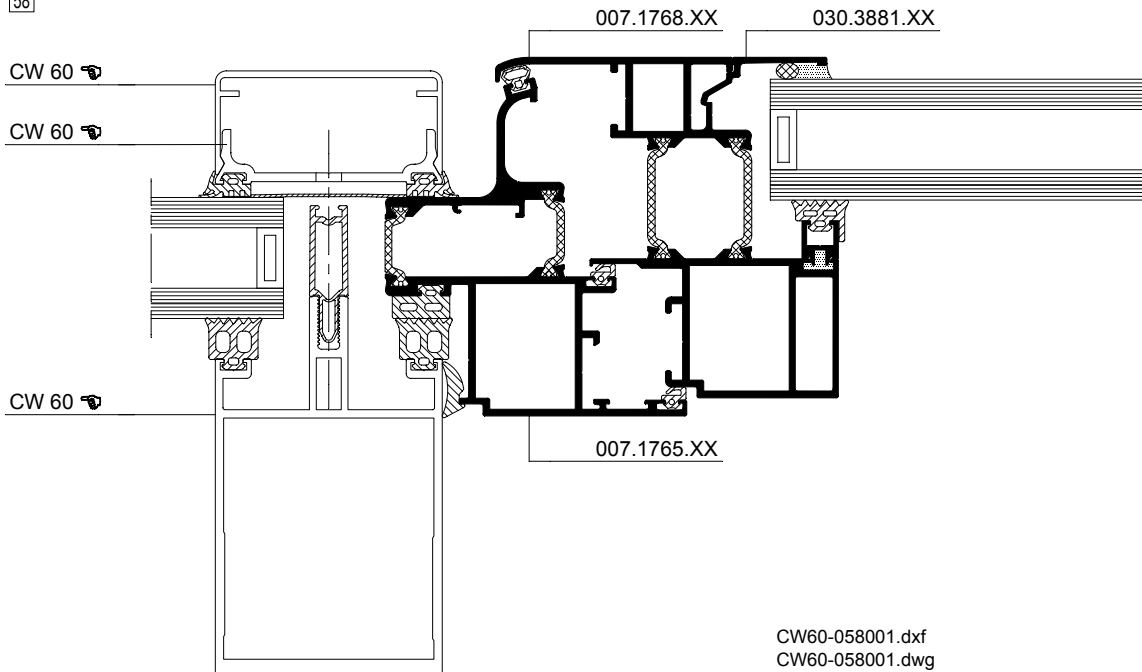

58

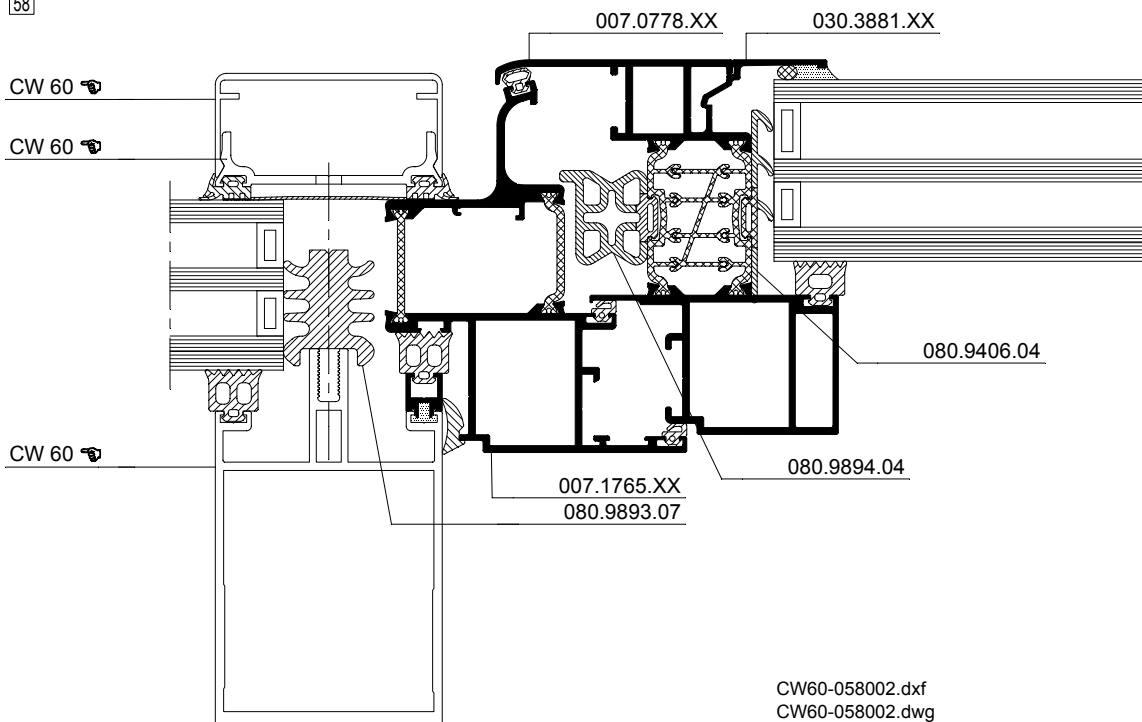

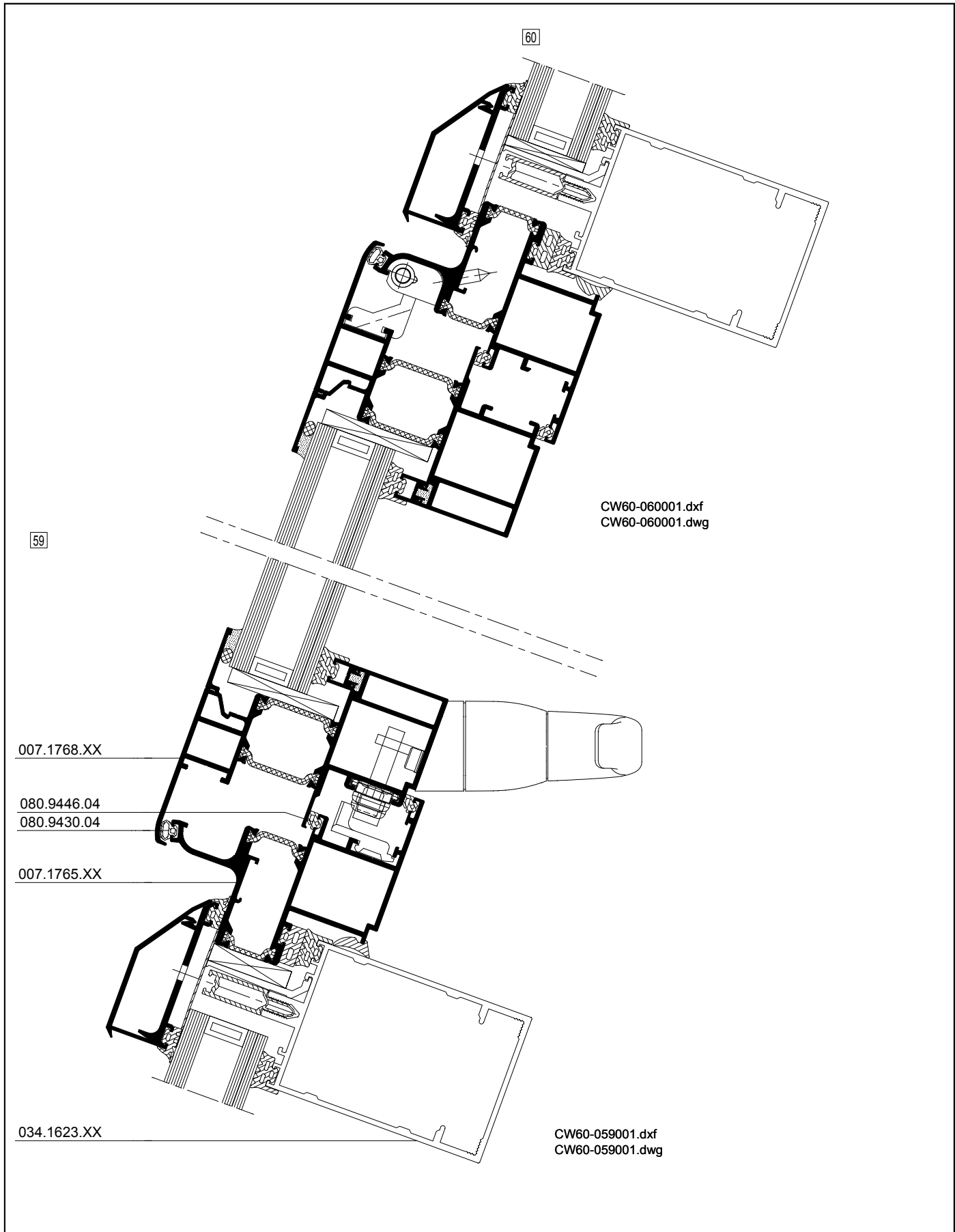
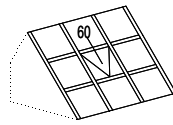
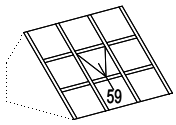

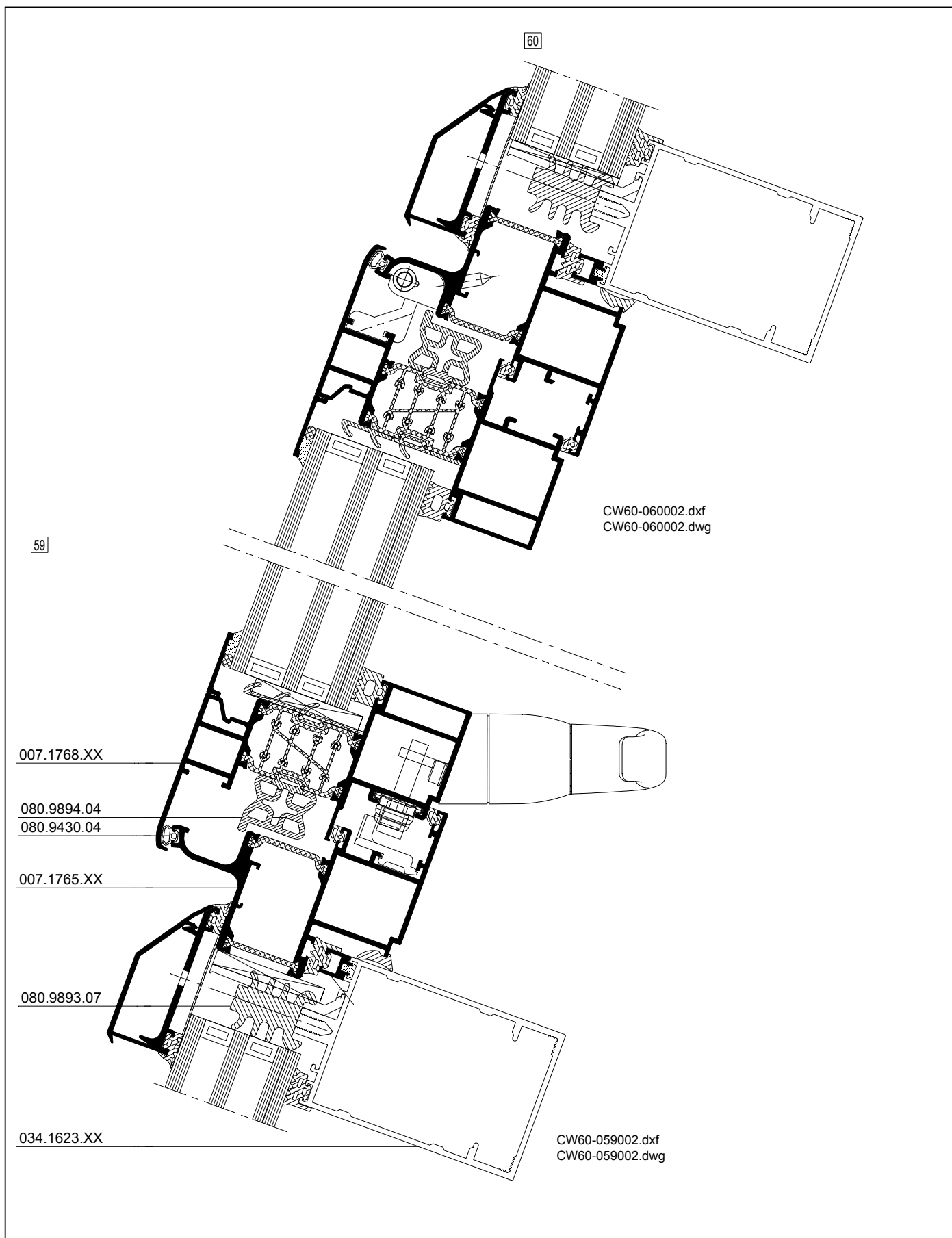
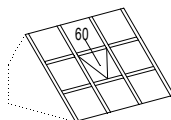
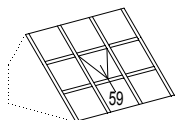

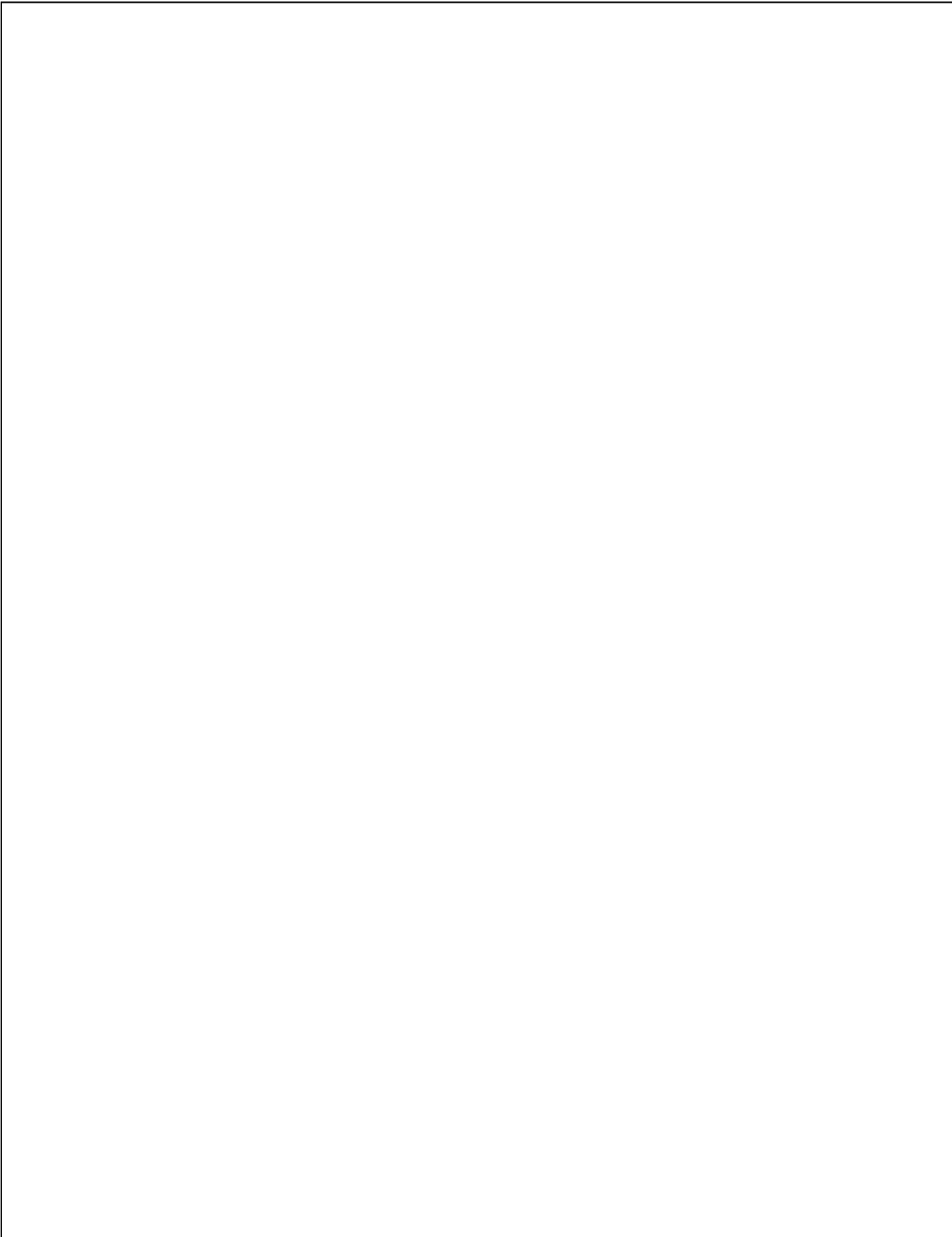

CW 60-HI



1 Structure interne

Structure interne verticale

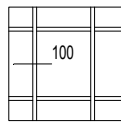

CW 60-HI - 150

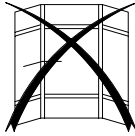
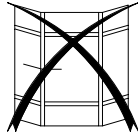

Structure interne horizontale

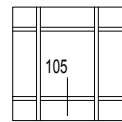

CW 60-HI - 153

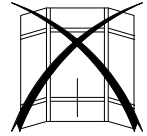
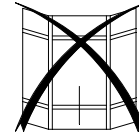

2 Esthétique extérieure

Serreur et capot - extérieur

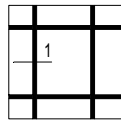

CW 60 - 007

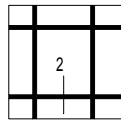

CW 60 - 008

3 Eléments fixes

Panneaux fixes

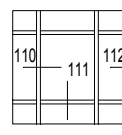
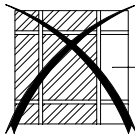
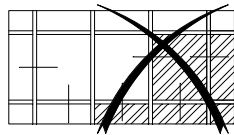

CW 60-HI - 157

4 Raccordements

Esthétique extérieure

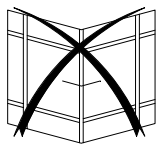
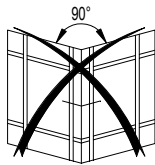

Dilatation

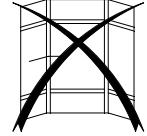
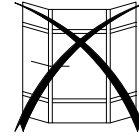
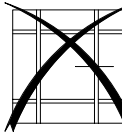

CW 60-HI

Interne structuur - Verticale interne structuur
Structure interne - Structure interne verticale
Internal structure - Vertical internal structure
Interne Struktur - Senkrechte interne Struktur

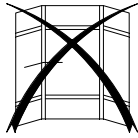
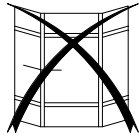
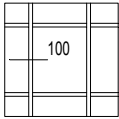

100

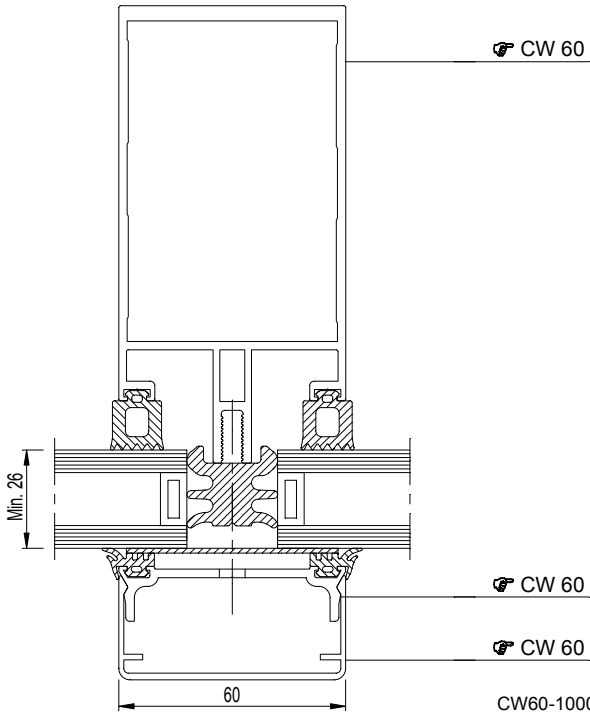

CW60-100001.dxf
CW60-100001.dwg

100

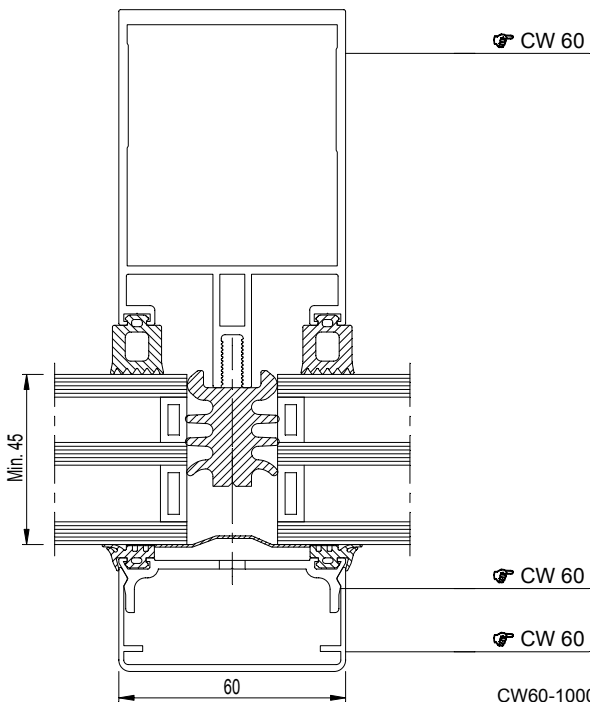

CW60-100002.dxf
CW60-100002.dwg

CW 60-HI

Interne structuur - Horizontale interne structuur
Structure interne - Structure interne horizontale
Internal structure - Horizontal internal structure
Interne Struktur - Horizontale interne Struktur

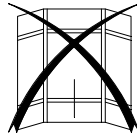
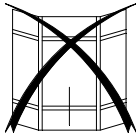
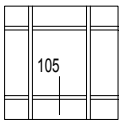

105

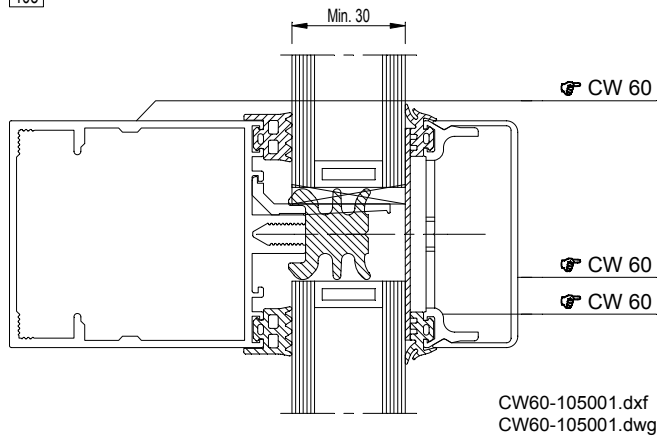

105

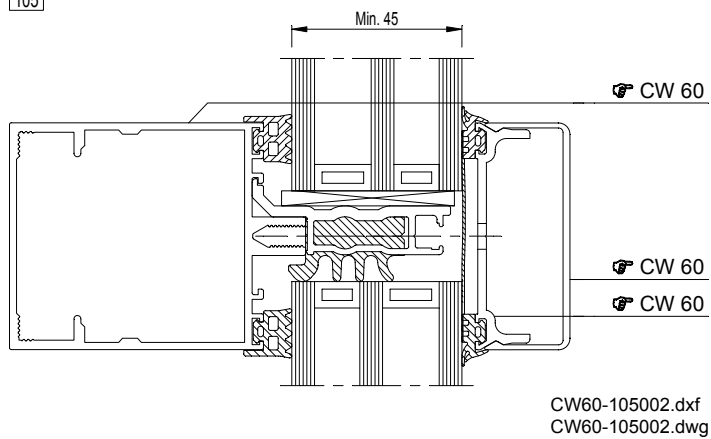

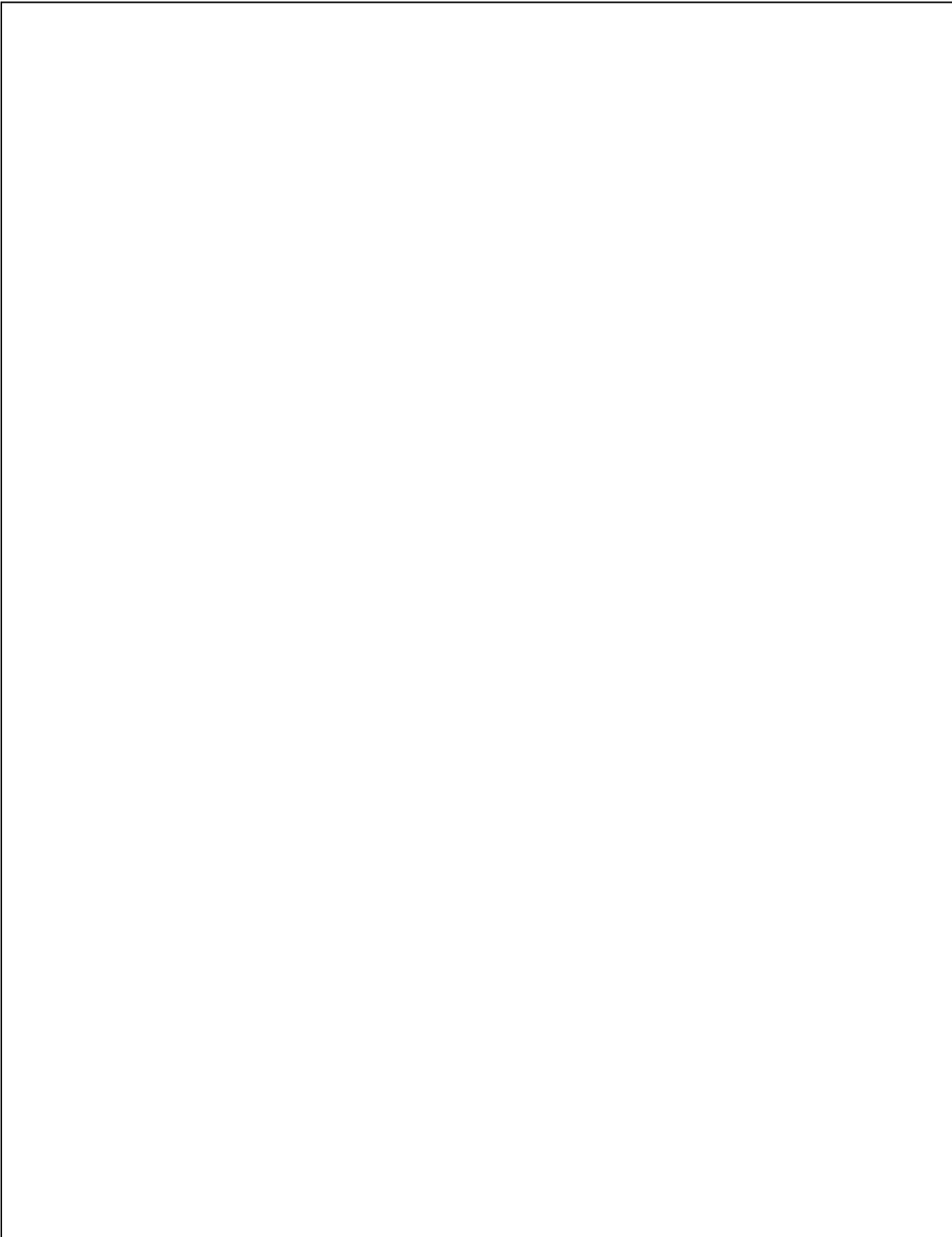

CW 60-HI

Vaste elementen - Vaste panelen
Eléments fixes - Panneaux fixes
Fixed elements - Fixed panels
Feste Elemente - Feste Füllungen



110	111	112

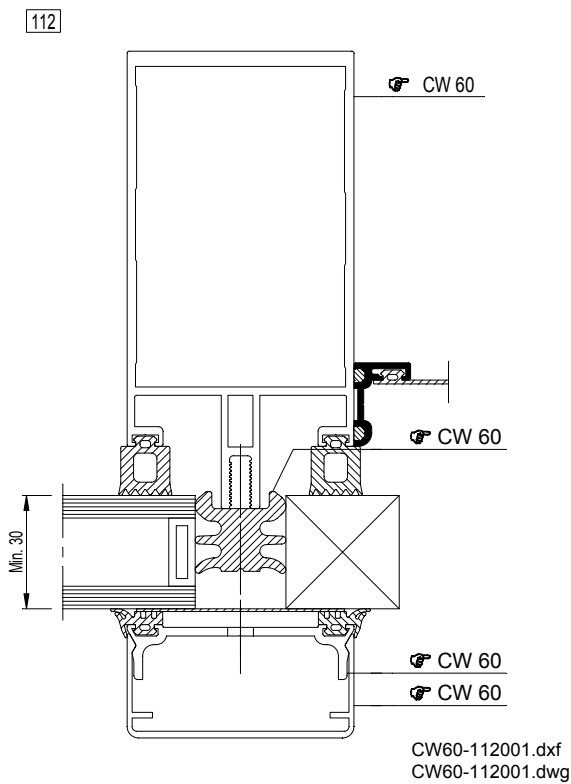
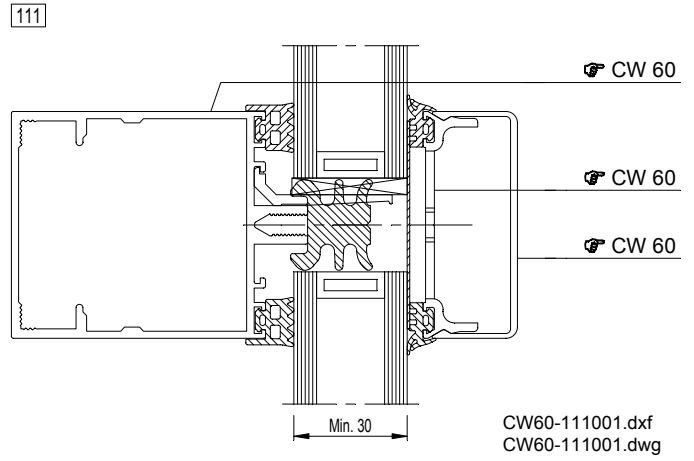
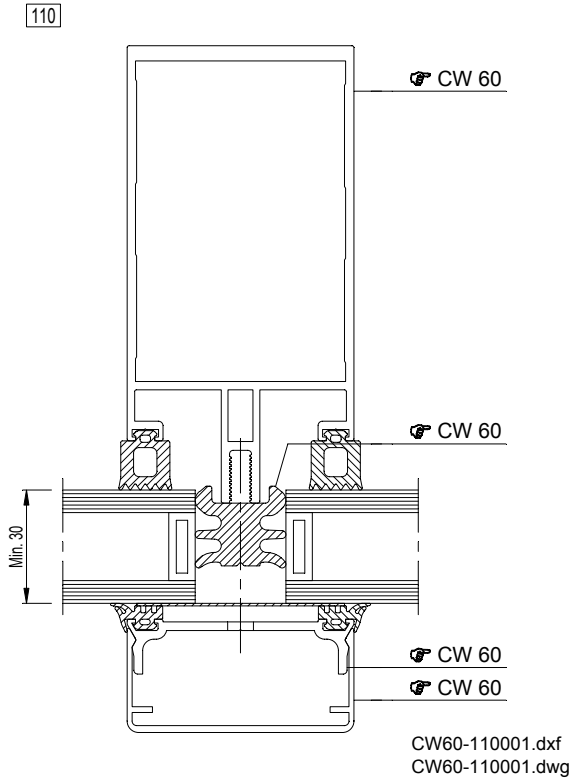

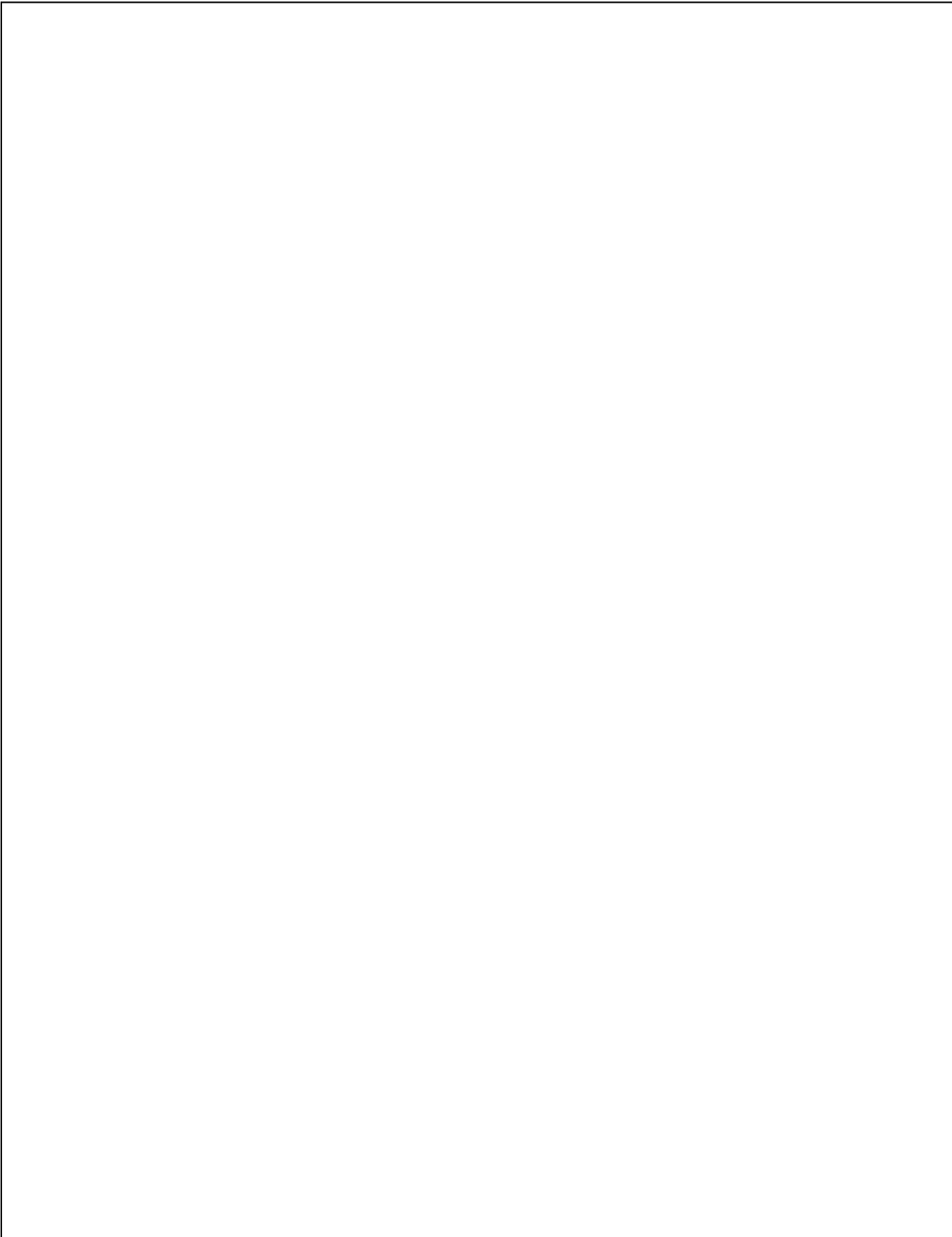

CW 60 Horizontal Lining



1 Structure interne

Structure interne verticale

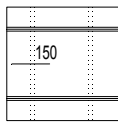

CW 60-HL - 200

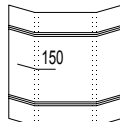

CW 60-HL - 200

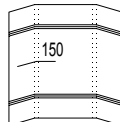

CW 60-HL - 200

Structure interne horizontale

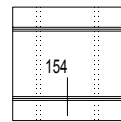

CW 60-HL - 201

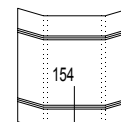

CW 60-HL - 201

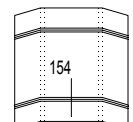

CW 60-HL - 201

2 Esthétique - extérieure

Serreur et capot - extérieur

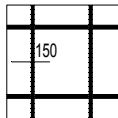

CW 60-HL - 202

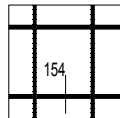

CW 60-HL - 202

3 Éléments fixes CW 60

Panneaux fixes

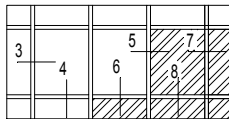

CW 60 - 010

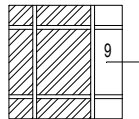

CW 60 - 011

4 Éléments ouvrants

Fenêtres avec ouvrants VEC

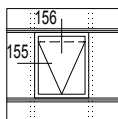

CW 60-HL - 204

5 Raccordements CW 60

Solutions d'angle

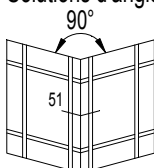

CW 60 - 030

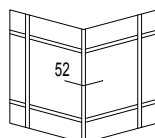

CW 60 - 032

Dilatation

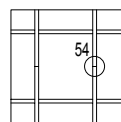

CW 60 - 034

CW 60-HL

Interne structuur - Verticale interne structuur
Structure interne - Structure interne verticale
Internal structure - Vertical internal structure
Interne Struktur - Senkrechte interne Struktur

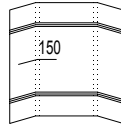
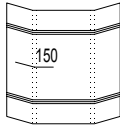
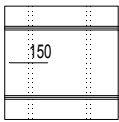

150

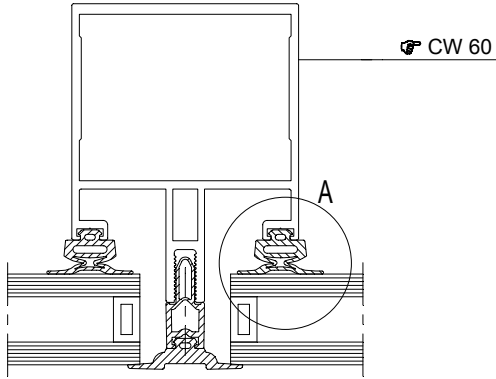

CW 60

CW60-150001.dxf
CW60-150001.dwg

MIN. 160°

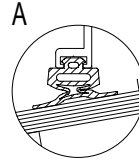

CW60-150002.dxf
CW60-150002.dwg

MIN. 200°

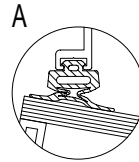

CW60-150003.dxf
CW60-150003.dwg

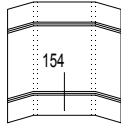
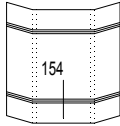
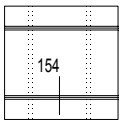

154

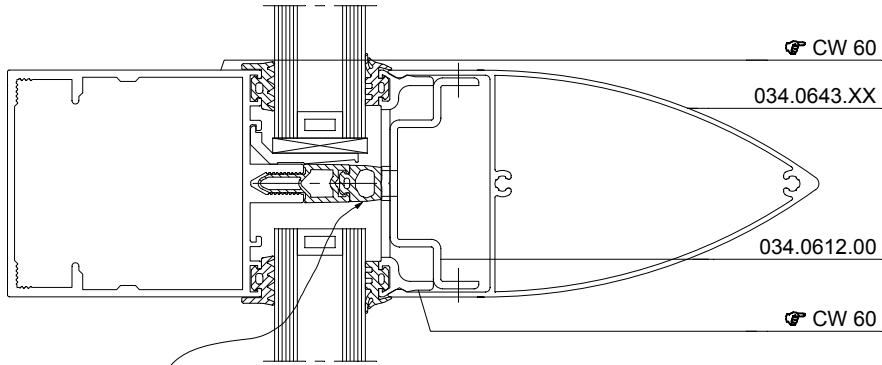

Horizontale compartentering is verplicht
Compartimentation horizontale est obligatoire
Horizontal compartmentalisation is obligatory
Horizontale Kompartimentierung ist verpflichtet

CW60-154001.dxf
CW60-154001.dwg

CW 60-HL

Esthetiek - buiten - Klemprofiel en afdekprofiel - buiten
Esthétique extérieure - Serreur et capot - extérieur
External aesthetics - External pressure plate and face cap
Ästhetik - außen - Glashalteprofil und Abdeckprofil - außen

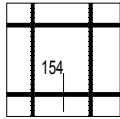
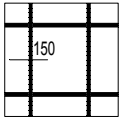

150

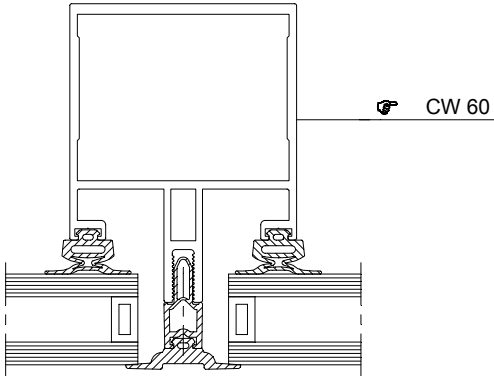

CW60-150001.dxf
CW60-150001.dwg

154

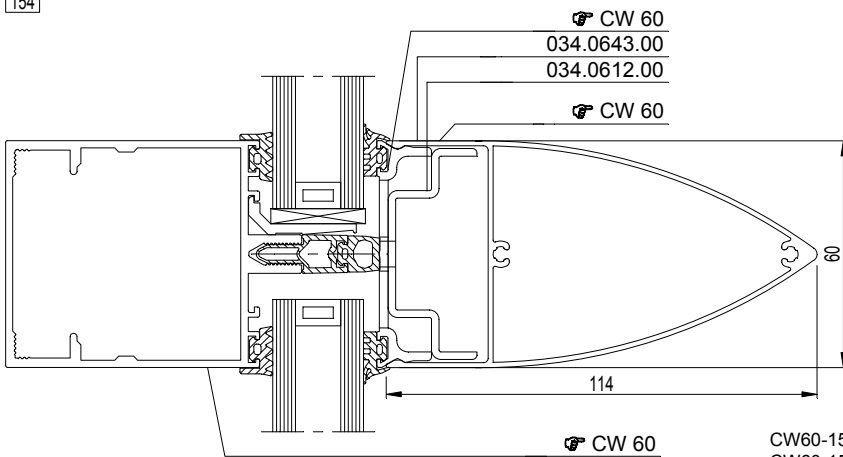

CW60-154002.dxf
CW60-154002.dwg

SSG

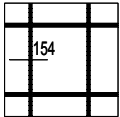

154

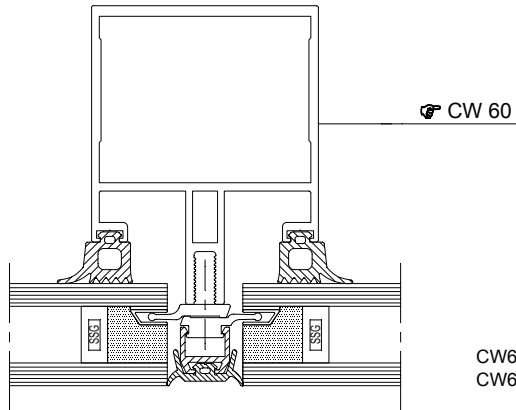

154

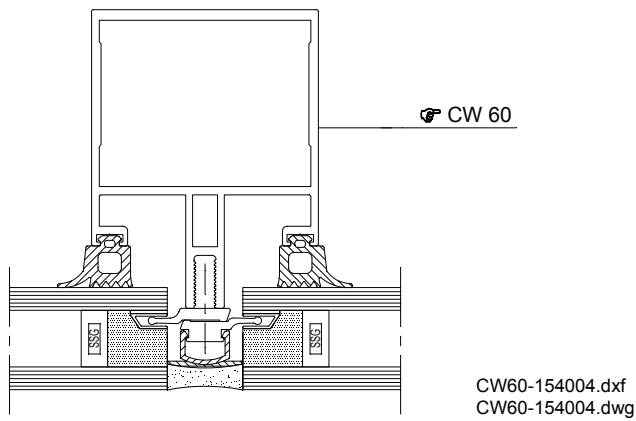

154

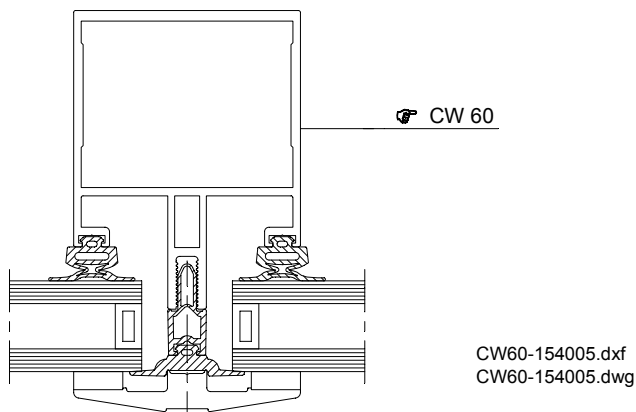

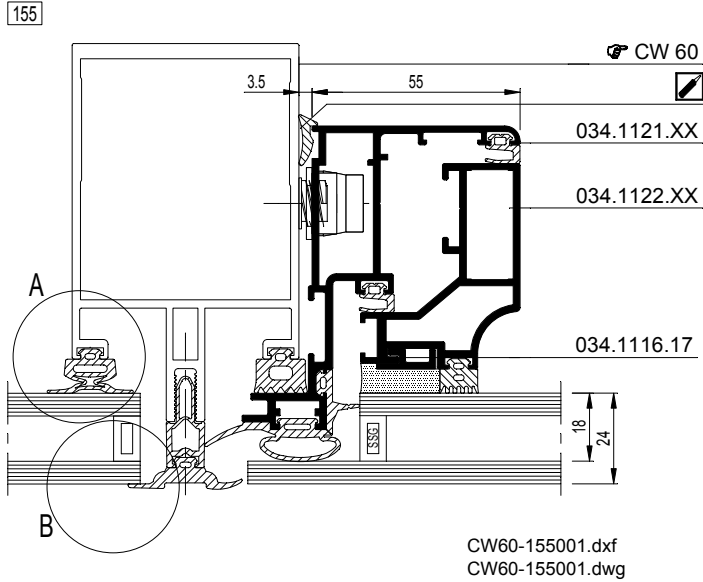
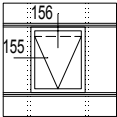

MIN. 170°

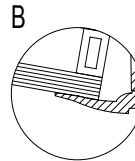
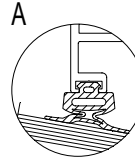

CW60-155002.dxf
 CW60-155002.dwg

MIN. 190°

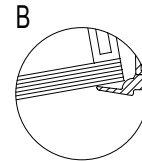
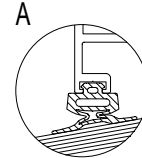

CW60-155003.dxf
 CW60-155003.dwg

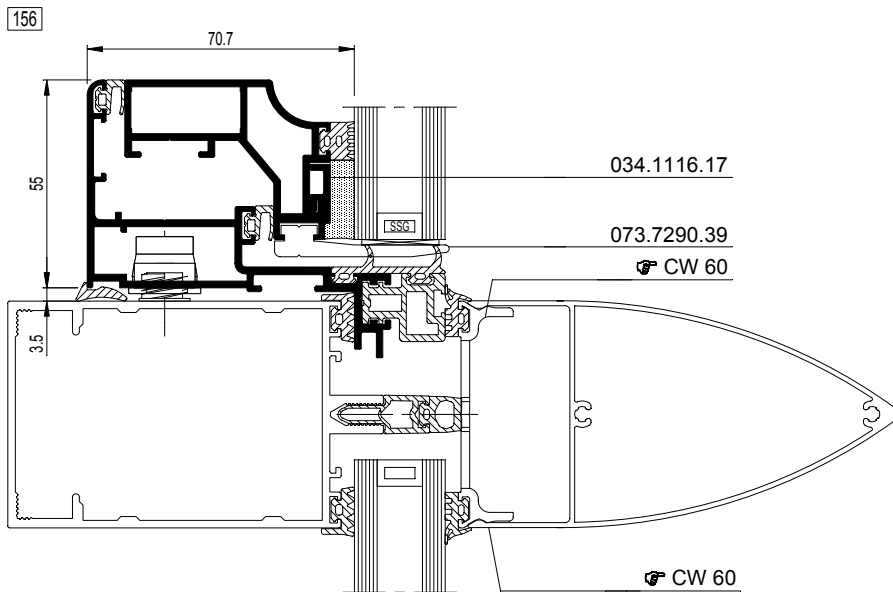

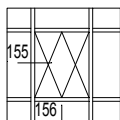

155

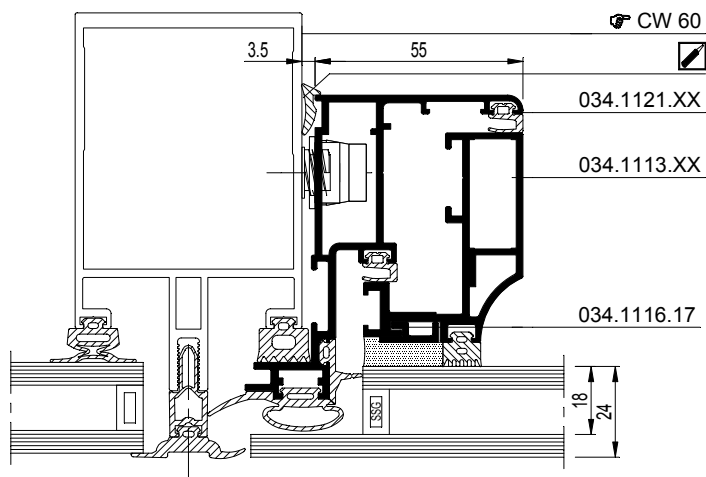

CW60-155004.dxf
 CW60-155004.dwg

156

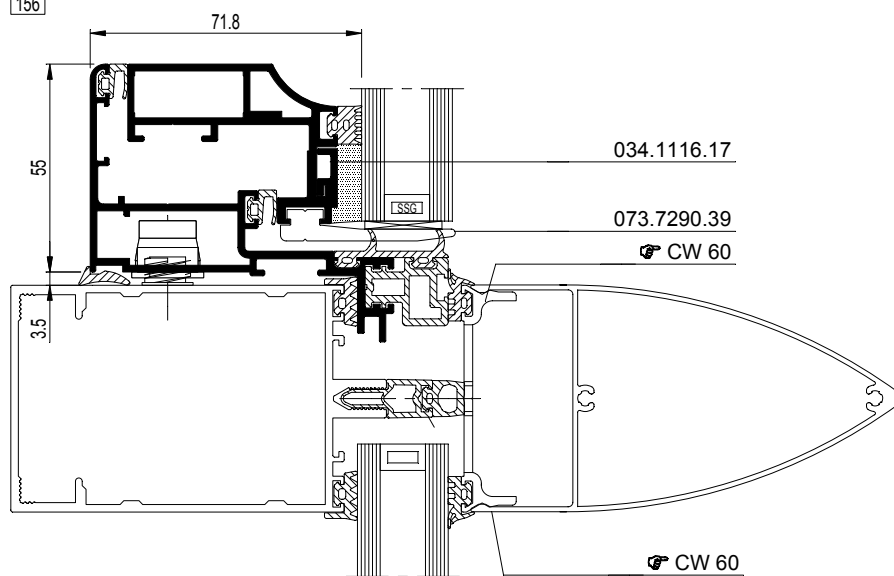

CW60-156002.dxf
 CW60-156002.dwg



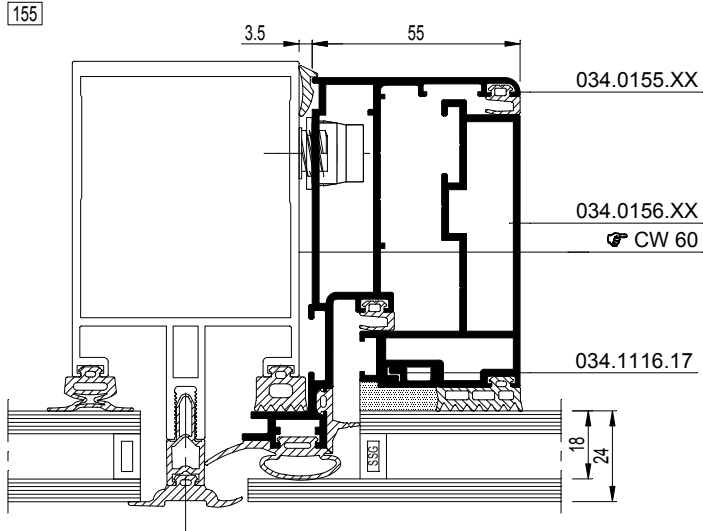
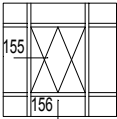

CW60-155005.dxf
CW60-155005.dwg

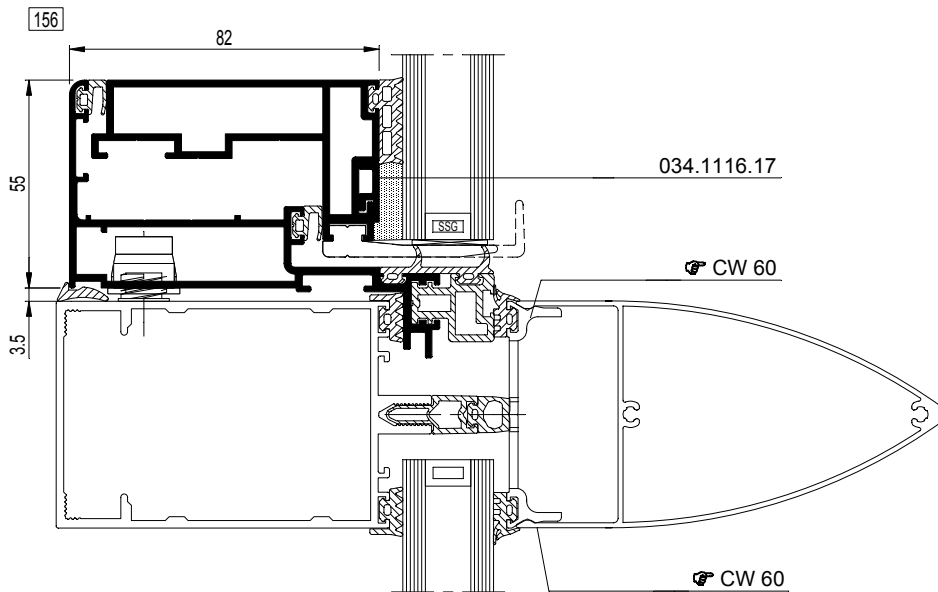

CW60-156003.dxf
CW60-156003.dwg



CW 60 Structural Clamped



1 Structure interne

Structure interne verticale

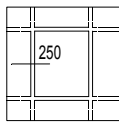

CW 60-SC - 252

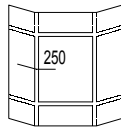

CW 60-SC - 252

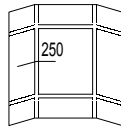

CW 60-SC - 252

Structure interne horizontale

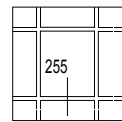

CW 60-SC - 254

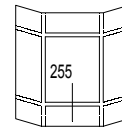

CW 60-SC - 254

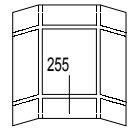

CW 60-SC - 254

2 Éléments fixes

Panneaux fixes

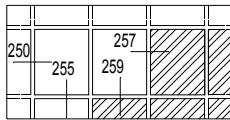

CW 60-SC - 255

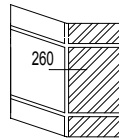

CW 60-SC - 257

3 Éléments ouvrants

Fenêtres avec ouvrants VEC

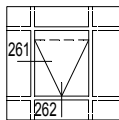

CW 60-SC - 258

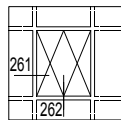

CW 60-SC - 259

4 Raccordements

Solutions d'angle

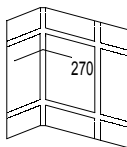

CW 60-SC - 265

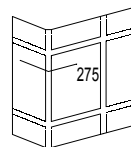

CW 60-SC - 267

Dilatation

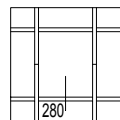

CW 60-SC - 269

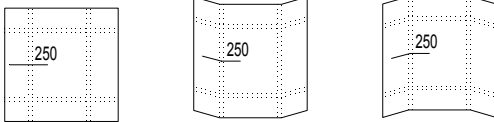

250

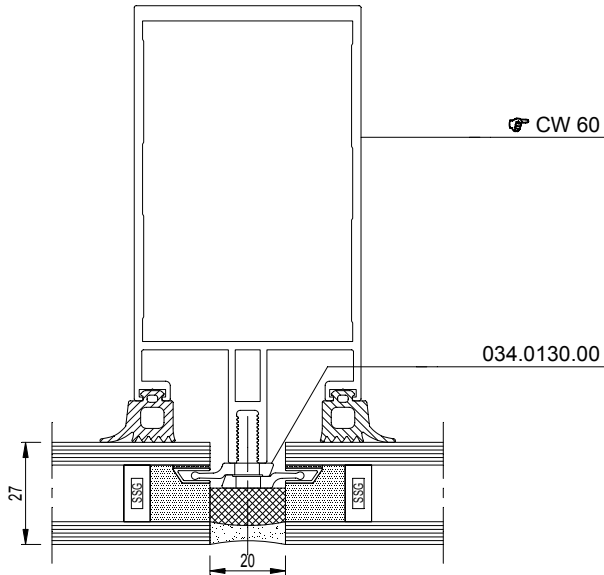

CW60-250001.dxf
 CW60-250001.dwg

VARIANTE

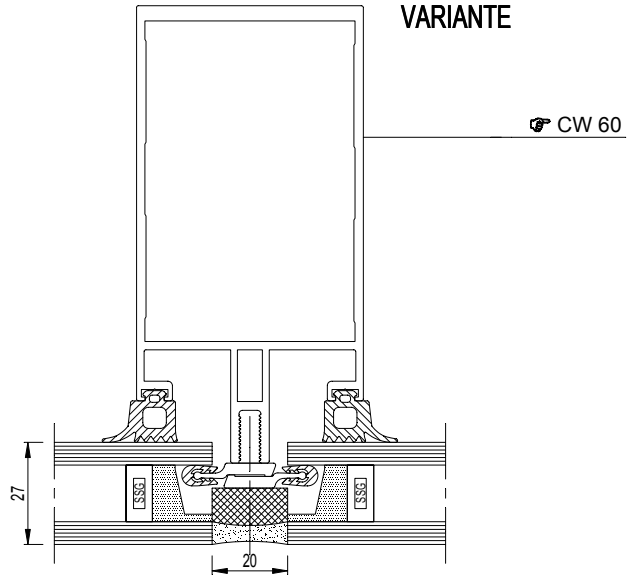

CW60-250003.dxf
 CW60-250003.dwg

250

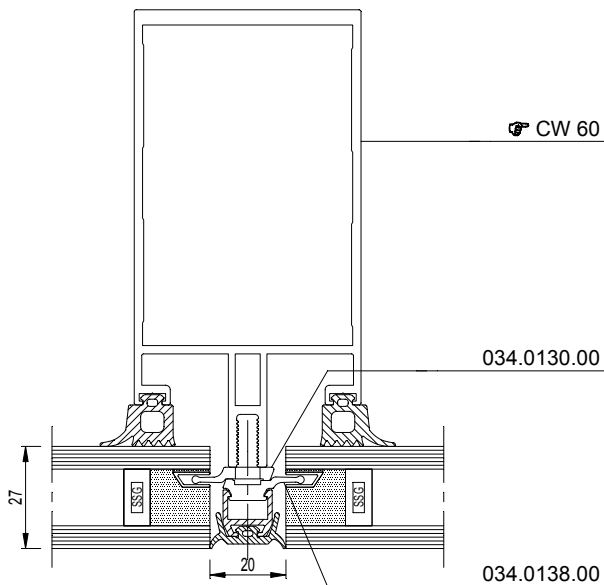

CW60-250002.dxf
 CW60-250002.dwg

VARIANTE

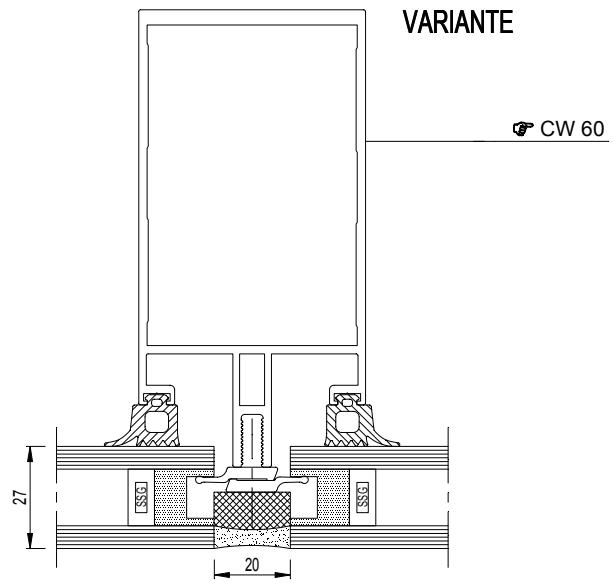

CW60-250004.dxf
 CW60-250004.dwg



CW 60-SC

Interne structuur - Verticale interne structuur
Structure interne - Structure interne verticale
Internal structure - Vertical internal structure
Interne Struktur - Senkrechte interne Struktur

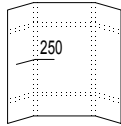
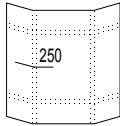
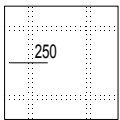

250

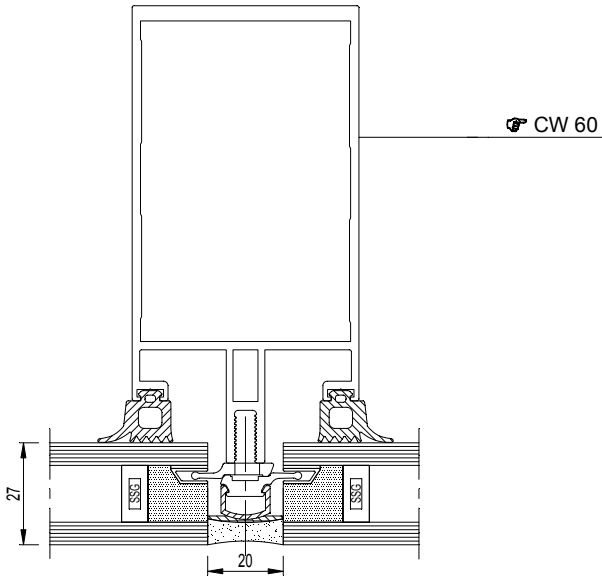

CW60-250005.dxf
CW60-250005.dwg

250

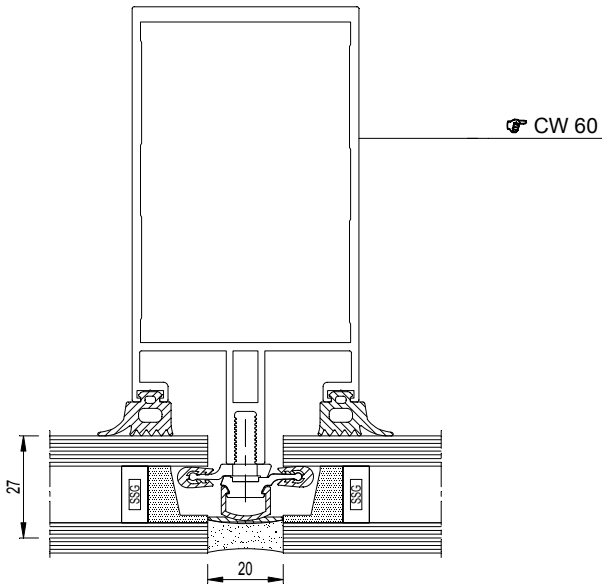

CW60-250006.dxf
CW60-250006.dwg



CW 60-SC

Structuur - Horizontale interne structuur
 Structure interne - Structure interne horizontale
 Internal structure - Horizontal internal structure
 Interne Struktur - Horizontale interne Struktur

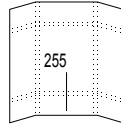
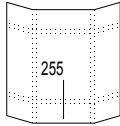
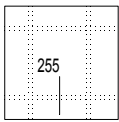

255

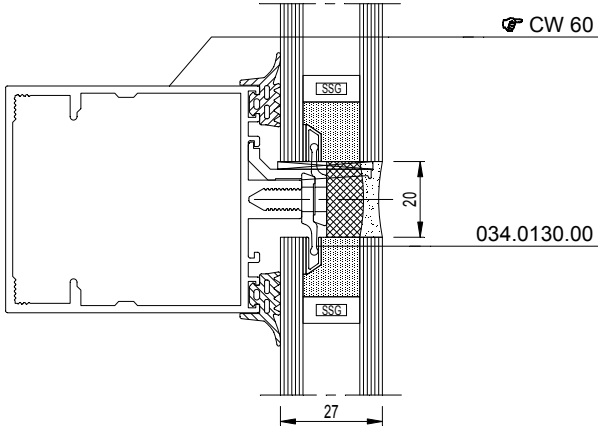

CW60-255001.dxf
 CW60-255001.dwg

255

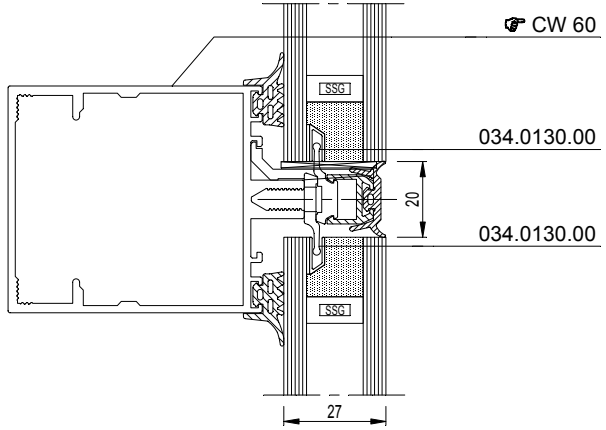

CW60-255002.dxf
 CW60-255002.dwg

255

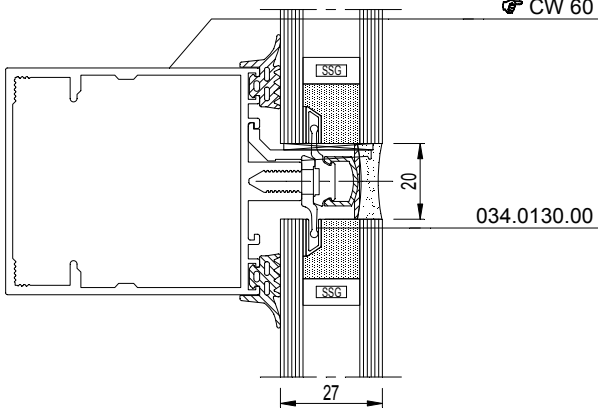

CW60-255003.dxf
 CW60-255003.dwg

255

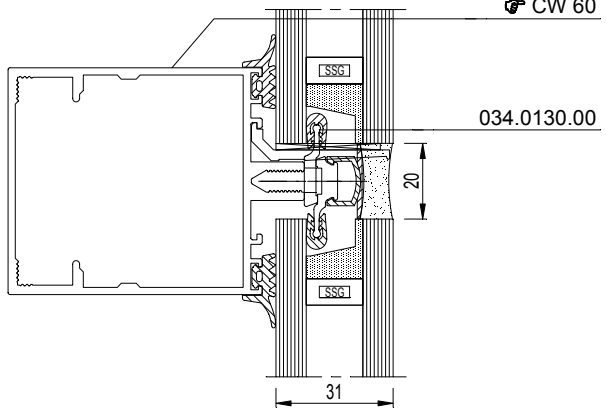

CW60-255004.dxf
 CW60-255004.dwg

255

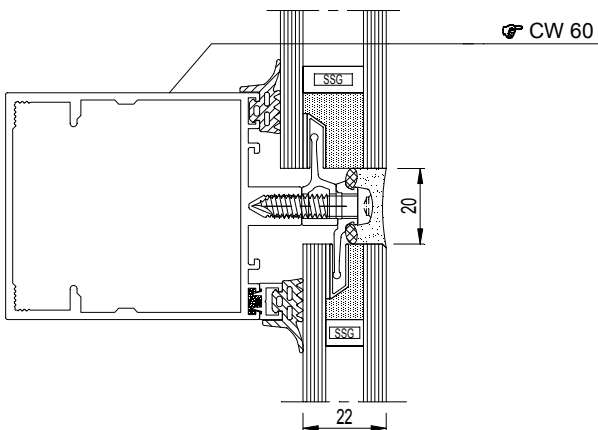

CW60-255005.dxf
 CW60-255005.dwg



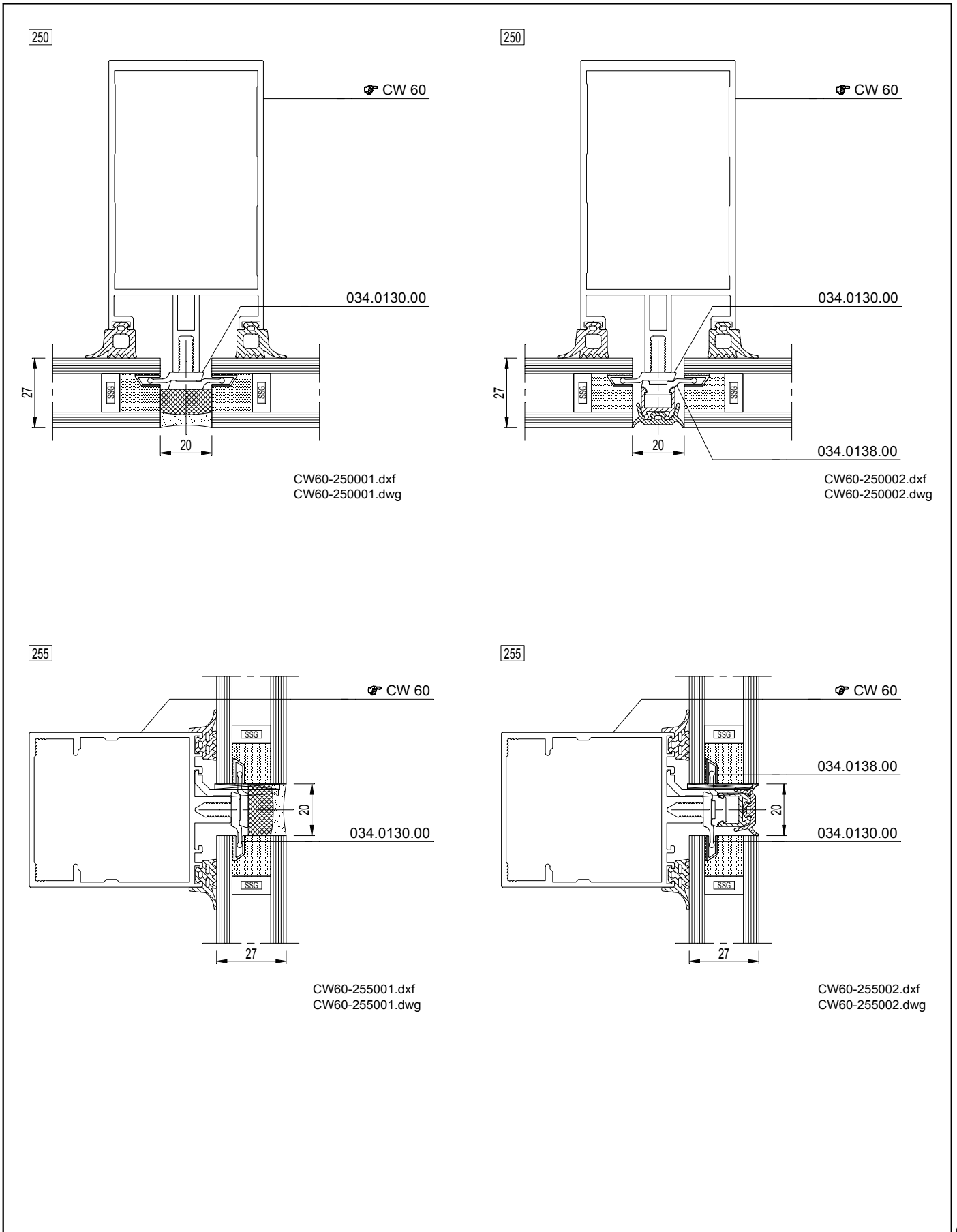
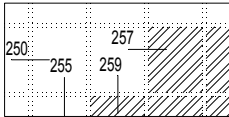

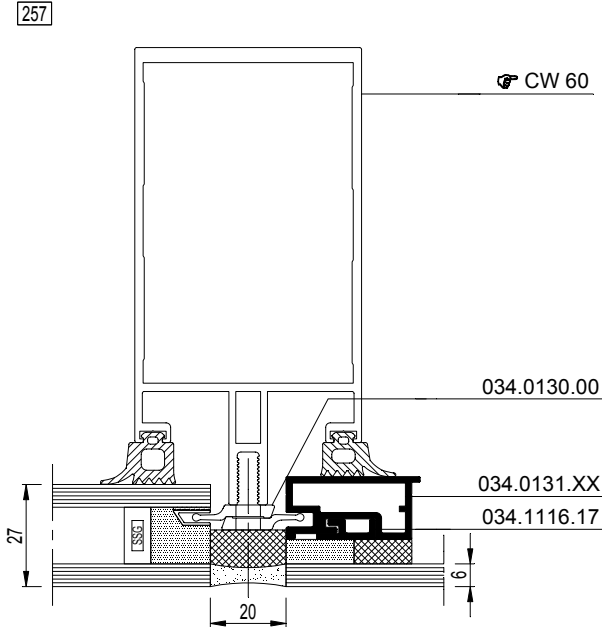
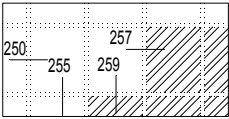

CW60-257001.dxf
 CW60-257001.dwg

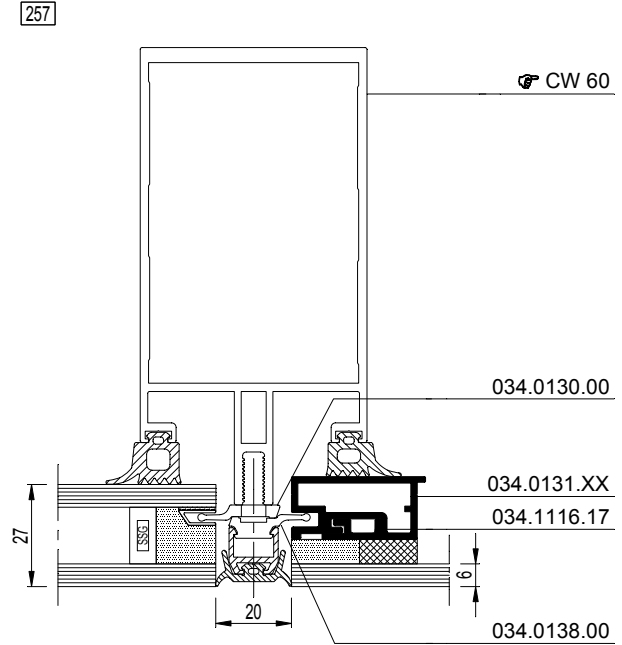

CW60-257002.dxf
 CW60-257002.dwg

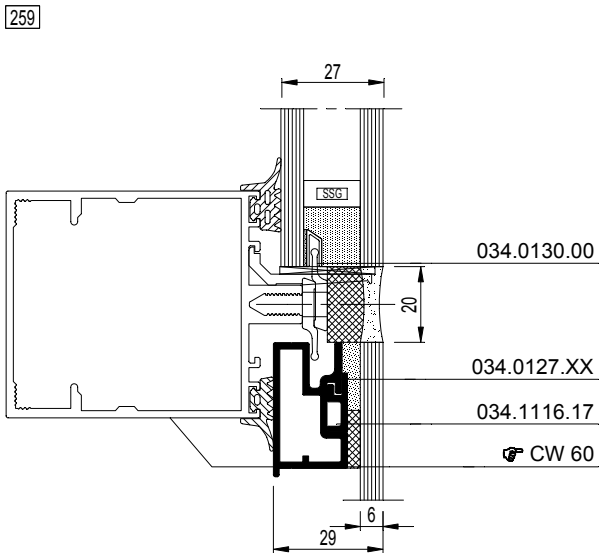

CW60-259001.dxf
 CW60-259001.dwg

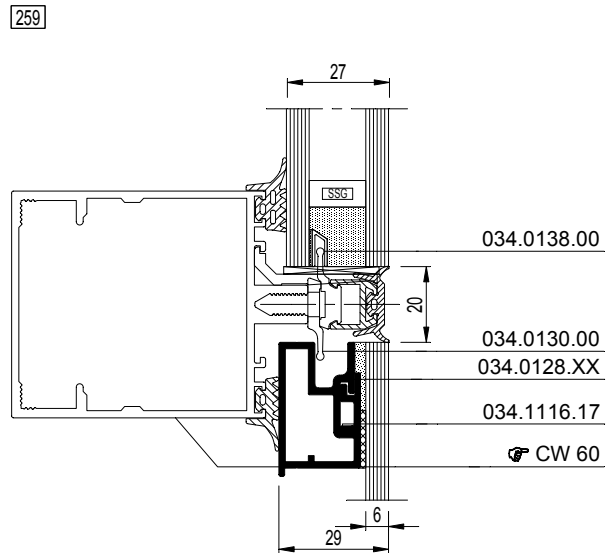

CW60-259002.dxf
 CW60-259002.dwg



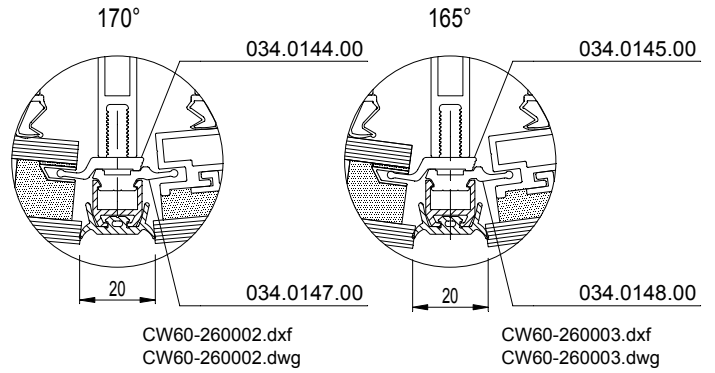
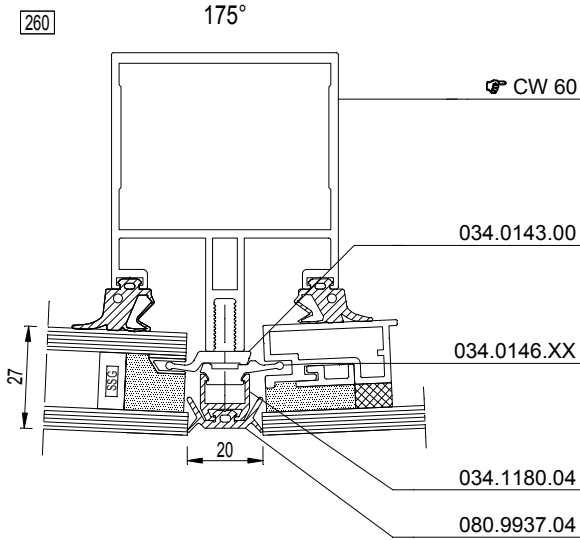
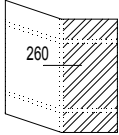

CW60-260001.dxf
CW60-260001.dwg

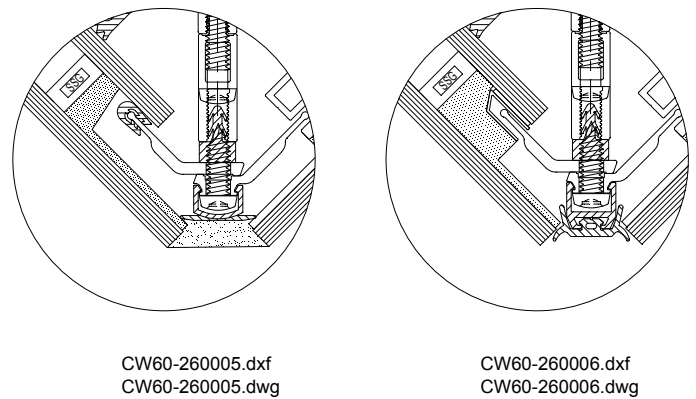
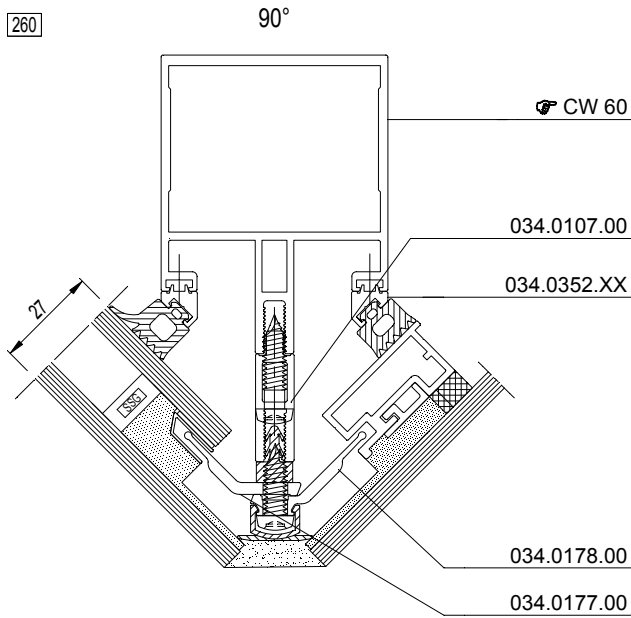

CW60-260004.dxf
CW60-260004.dwg



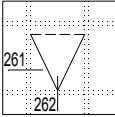

261

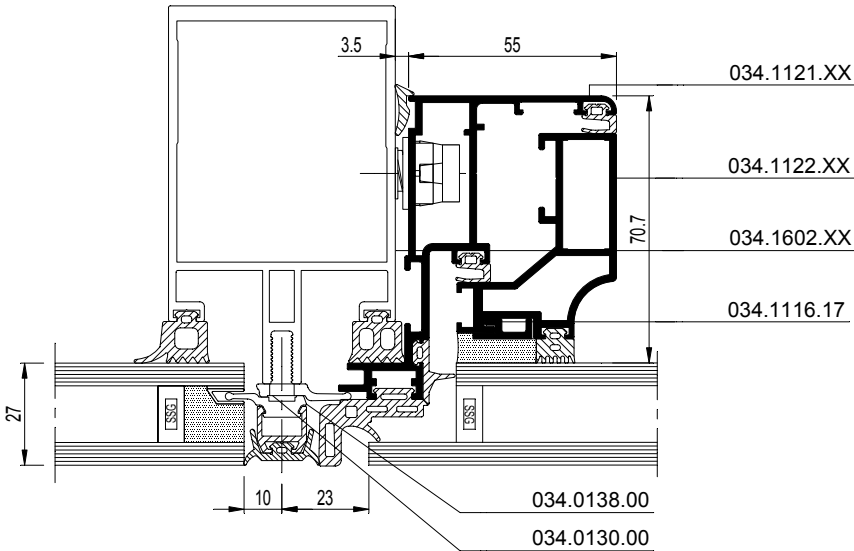

CW60-261001.dxf
 CW60-261001.dwg

262

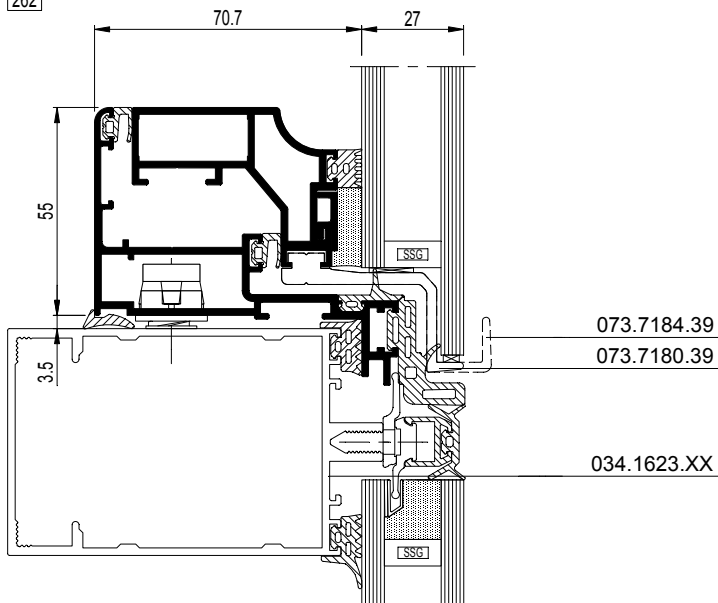

CW60-262001.dxf
 CW60-262001.dwg



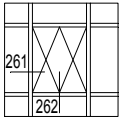

261

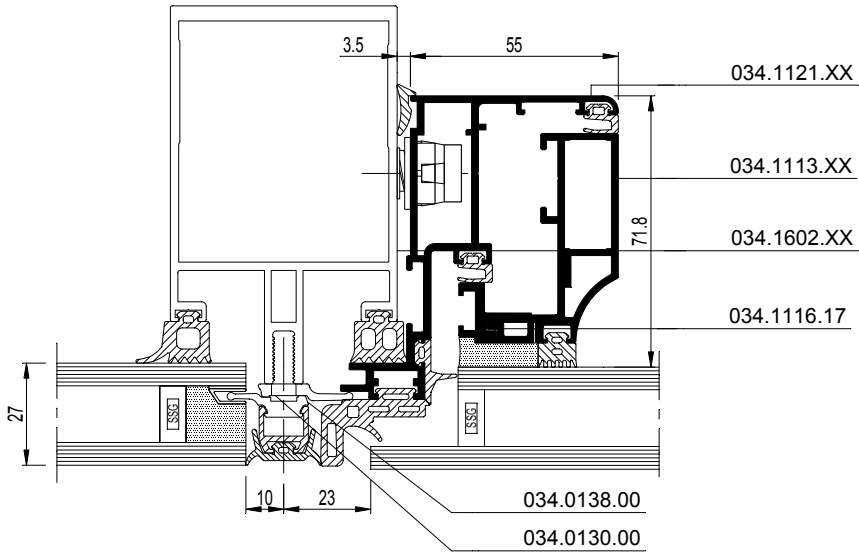

CW60-261002.dxf
 CW60-261002.dwg

262

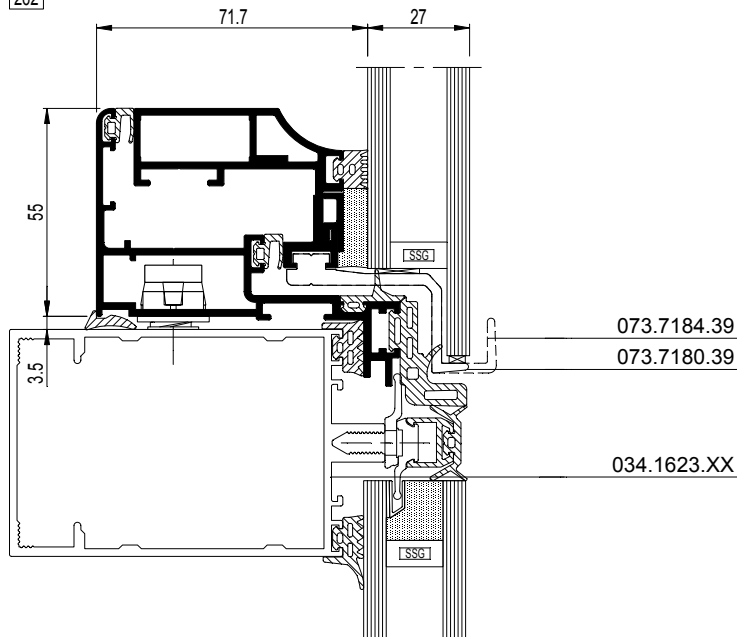

CW60-262002.dxf
 CW60-262002.dwg



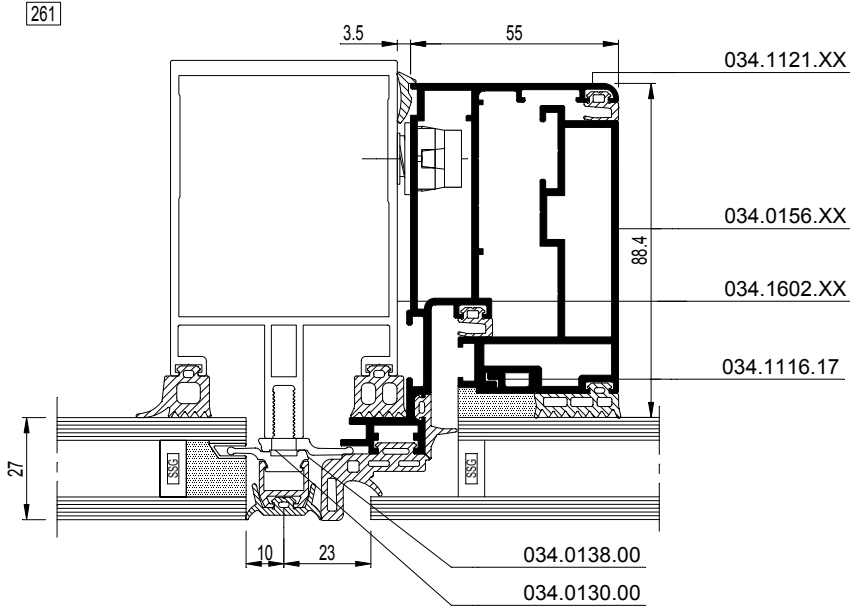
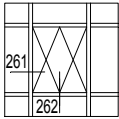

CW60-261003.dxf
 CW60-261003.dwg

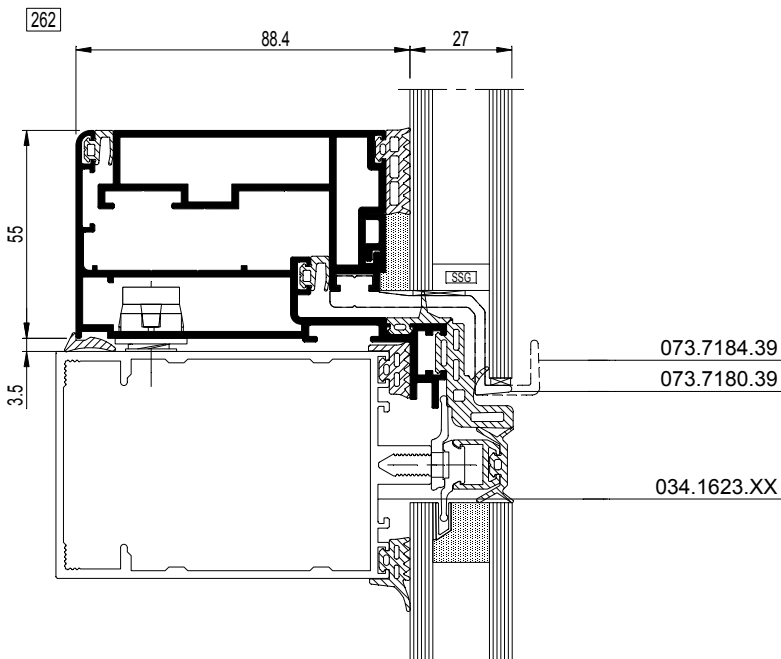

CW60-262003.dxf
 CW60-262003.dwg



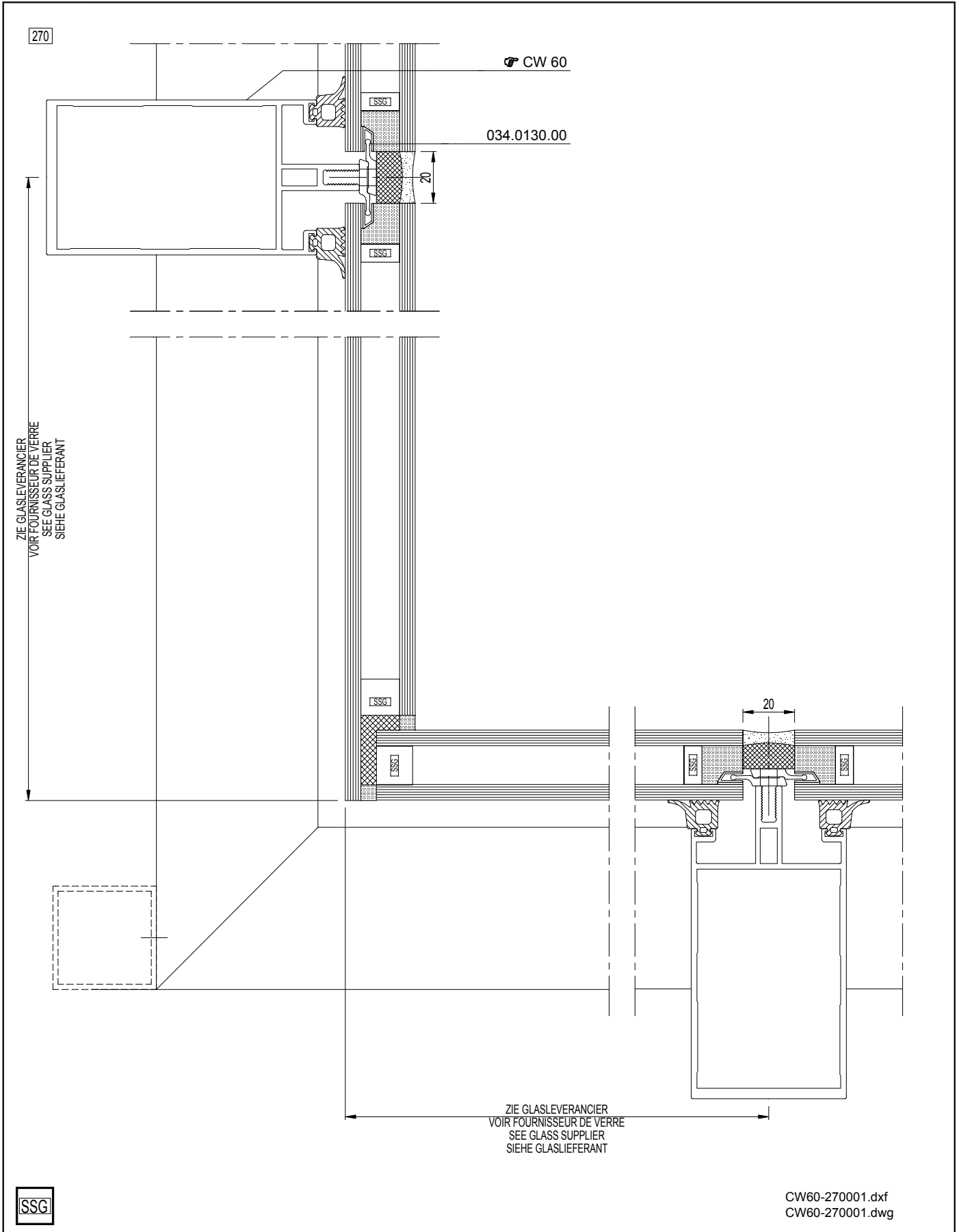
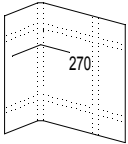

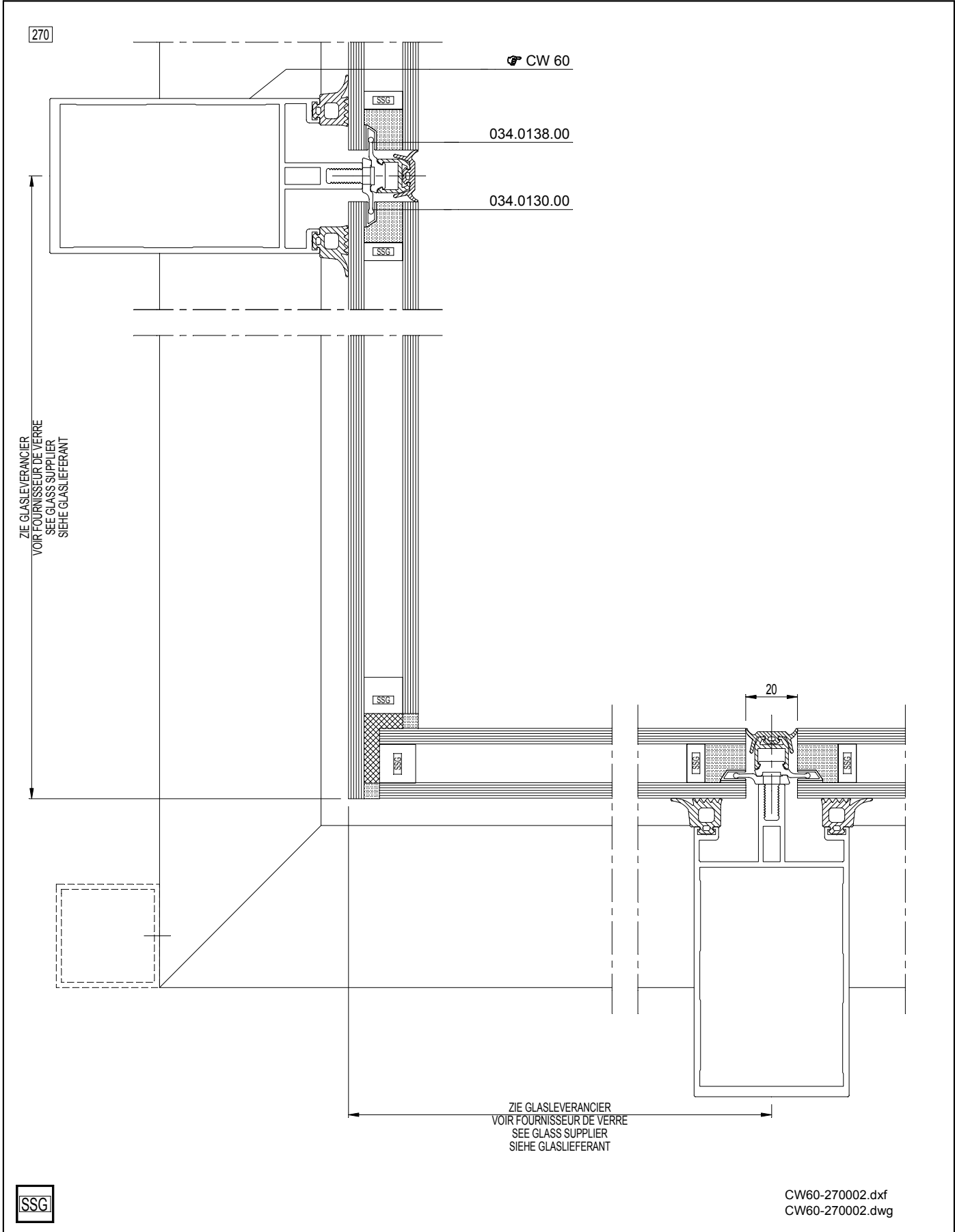
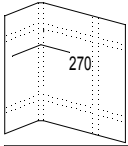

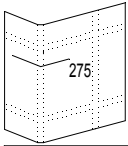

275

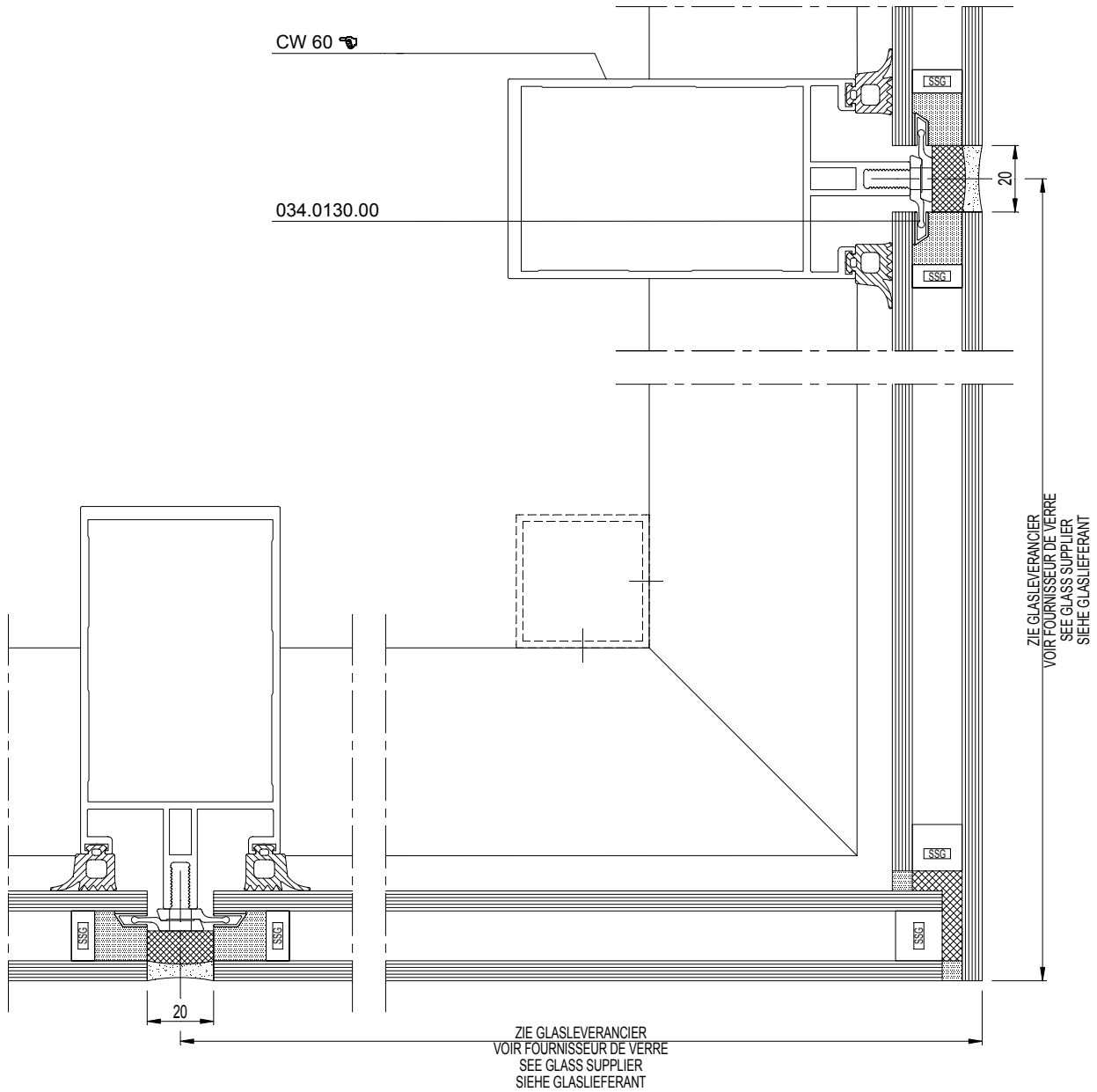

CW60-275001.dxf
CW60-275001.dwg



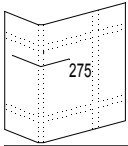

275

CW 60

034.0130.00

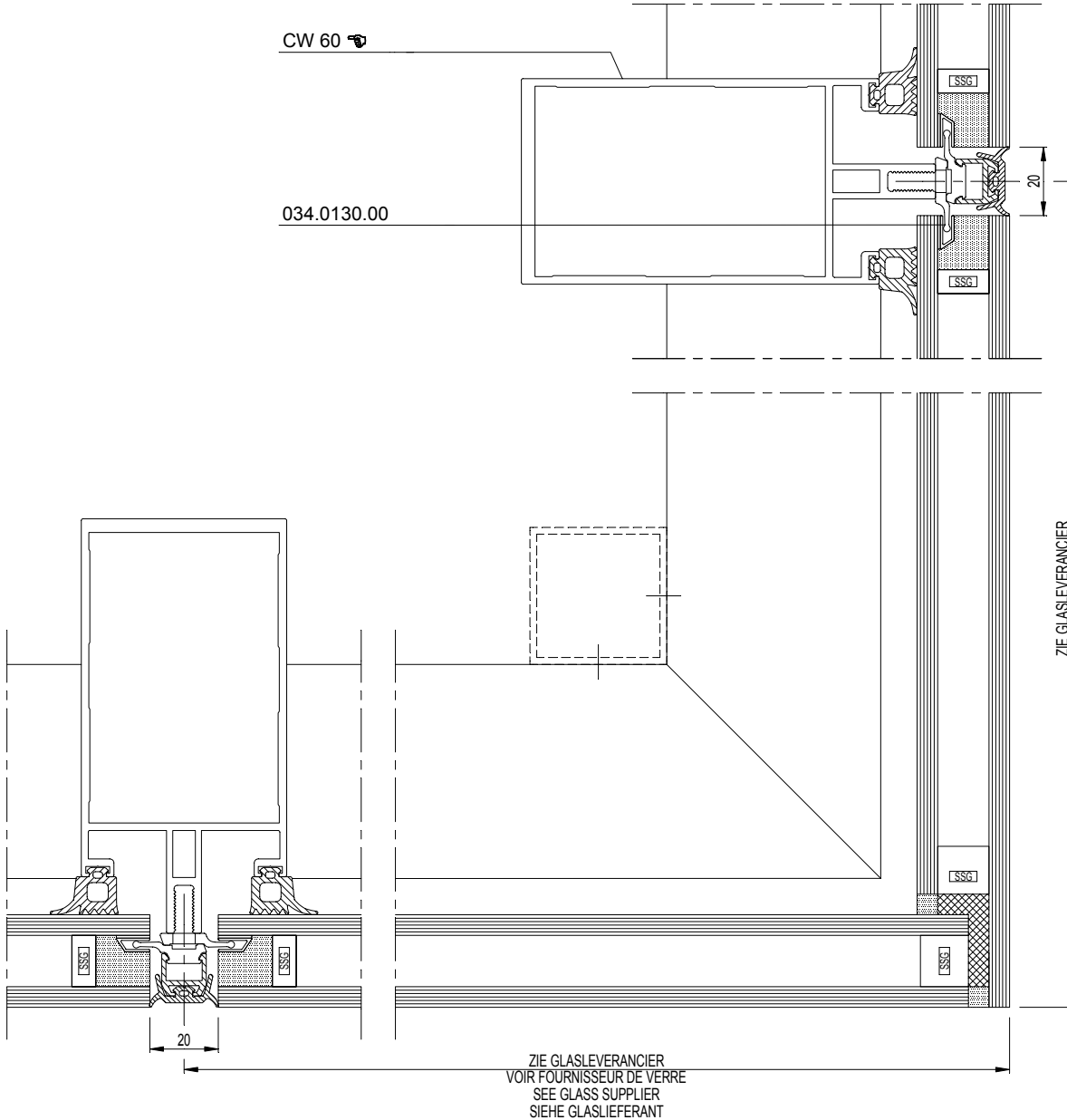

ZIE GLASLEVERANCIER
VOIR FOURNISSEUR DE VERRE
SEE GLASS SUPPLIER
SIEHE GLASLIEFERANT

ZIE GLASLEVERANCIER
VOIR FOURNISSEUR DE VERRE
SEE GLASS SUPPLIER
SIEHE GLASLIEFERANT

CW60-275002.dxf
CW60-275002.dwg



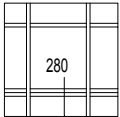

280

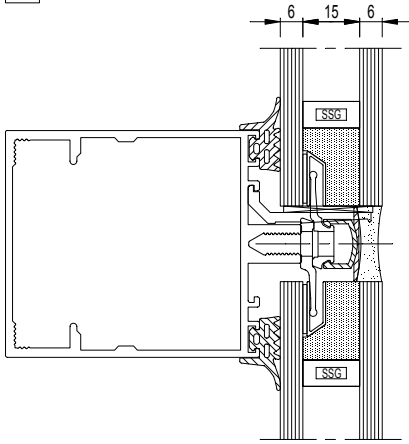

CW60-280001.dxf
CW60-280001.dwg

280

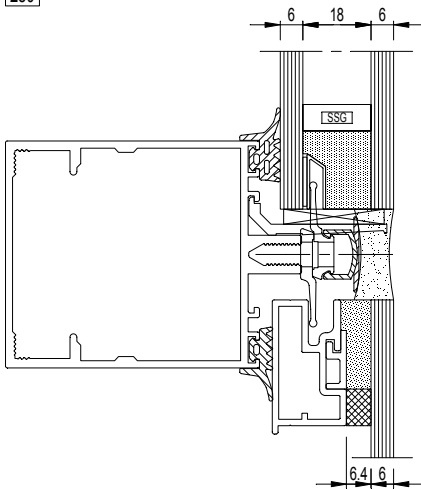

CW60-280002.dxf
CW60-280002.dwg

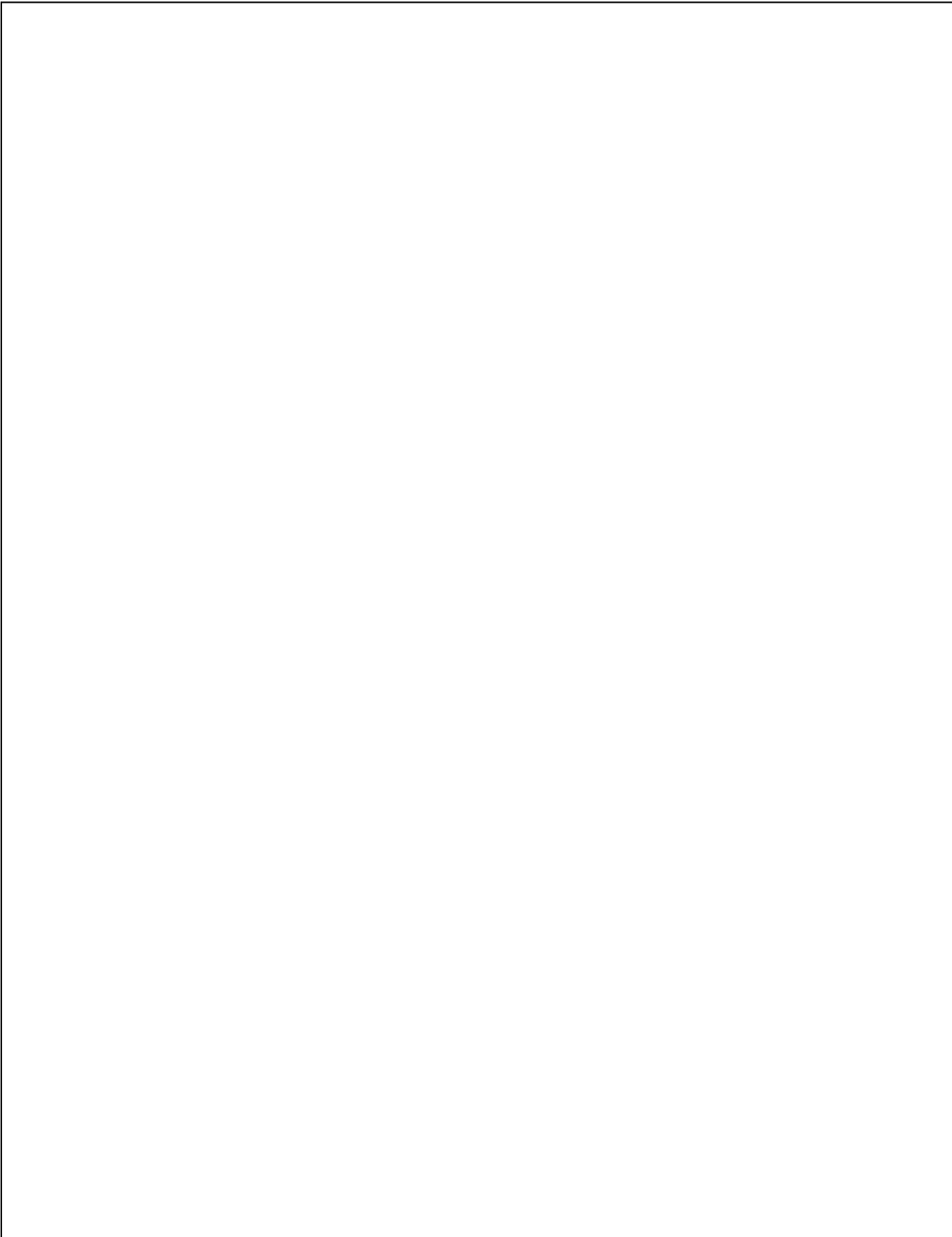

CW 60 Structural Glazing



1 Structure interne

Structure interne verticale

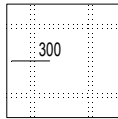

CW 60-SG - 302

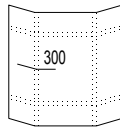

CW 60-SG - 302

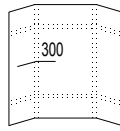

CW 60-SG - 302

Structure interne horizontale

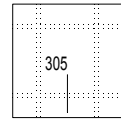

CW 60-SG - 303

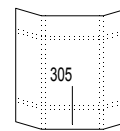

CW 60-SG - 303

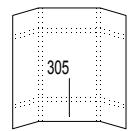

CW 60-SG - 303

2 Raccordements

Solutions d'angle

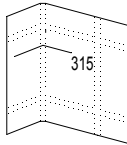

CW 60-SG - 310

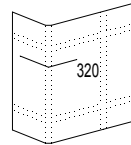

CW 60-SG - 311

Dilatation

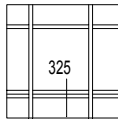

CW 60-SC - 313

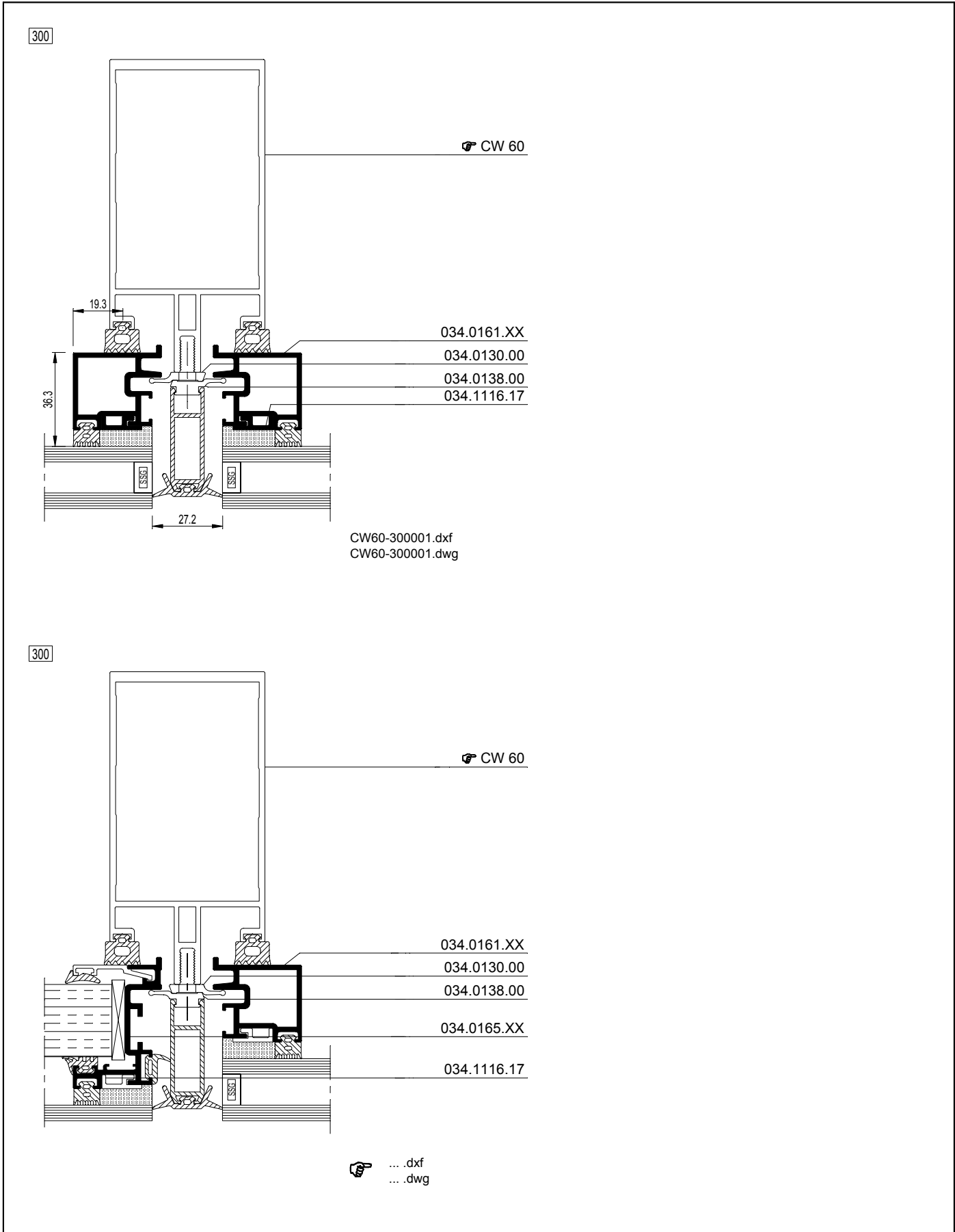
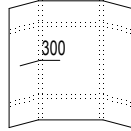
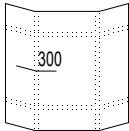
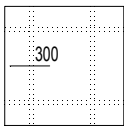

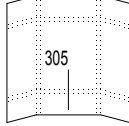
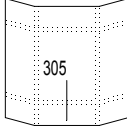
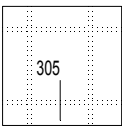

305

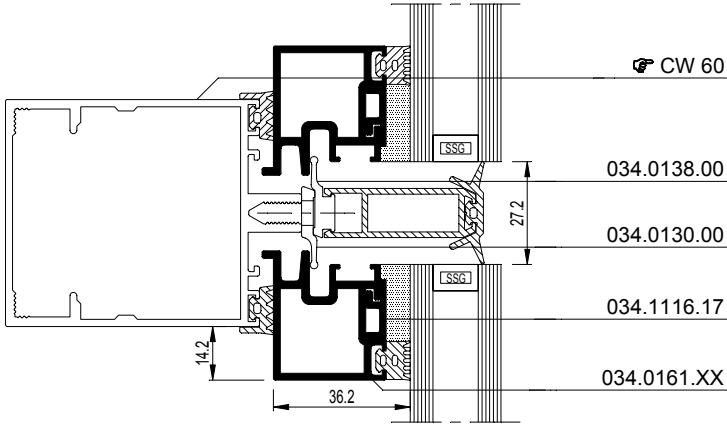

CW60-305001.dxf
 CW60-305001.dwg

305

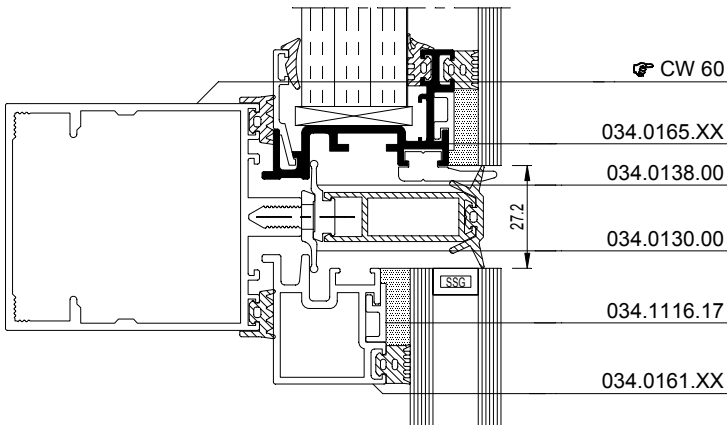

... .dxf
dwg

034.0165.XX

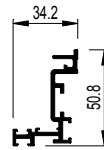

300 CW60-300002.dxf
 CW60-300002.dwg

305 CW60-305002.dxf
 CW60-305002.dwg

034.0166.XX

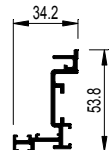

300 CW60-300003.dxf
 CW60-300003.dwg

305 CW60-305003.dxf
 CW60-305003.dwg

034.0167.XX

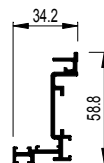

300 CW60-300004.dxf
 CW60-300004.dwg

305 CW60-305004.dxf
 CW60-305004.dwg

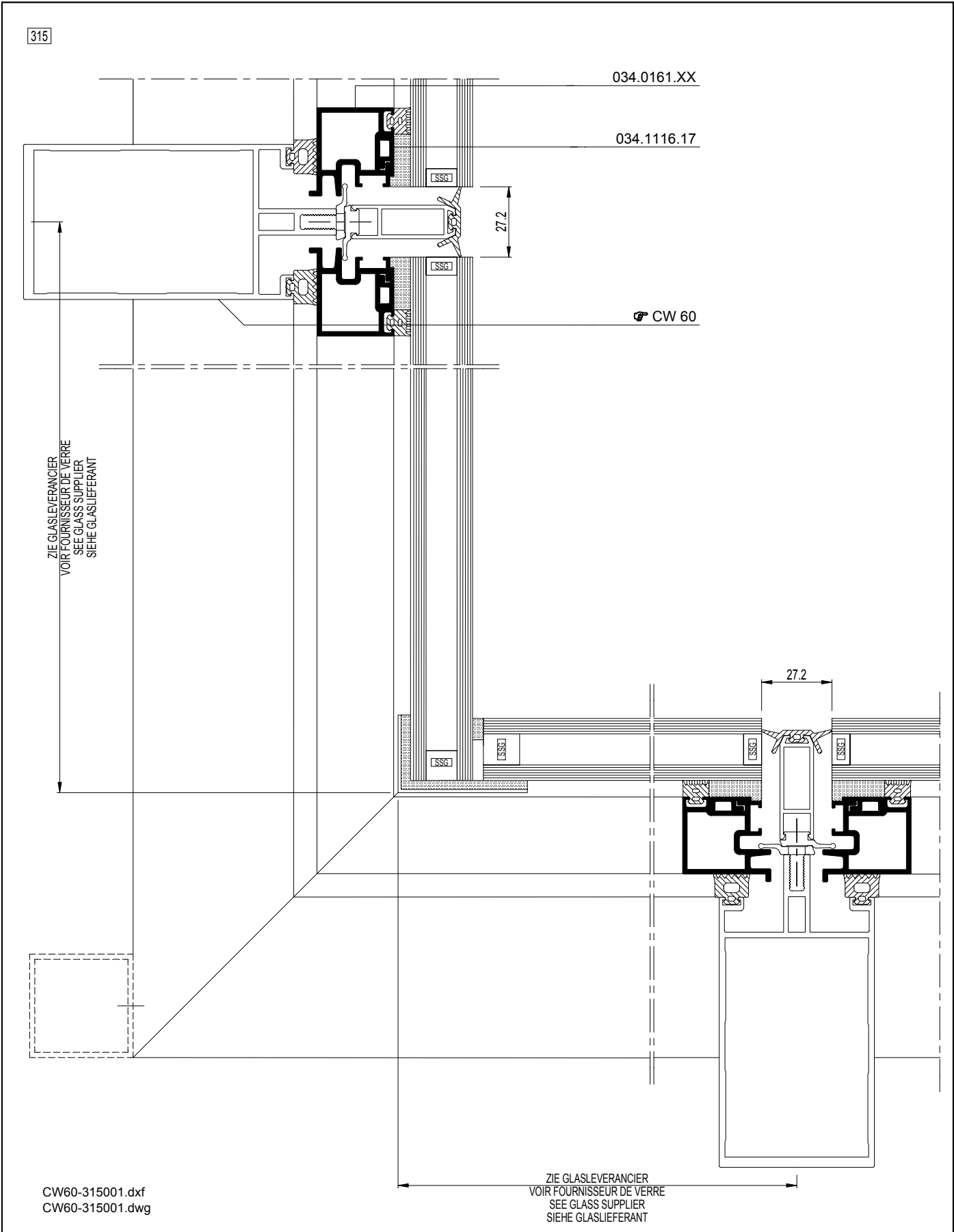
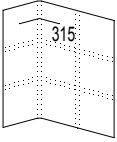

CW60-315001.dxf
CW60-315001.dwg

ZIE GLASLEVERANCIER
VOIR FOURNISSEUR DE VERRE
SEE GLASS SUPPLIER
SIEHE GLASLIEFERANT

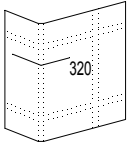

320

034.0116.XX

034.1116.17

CW 60

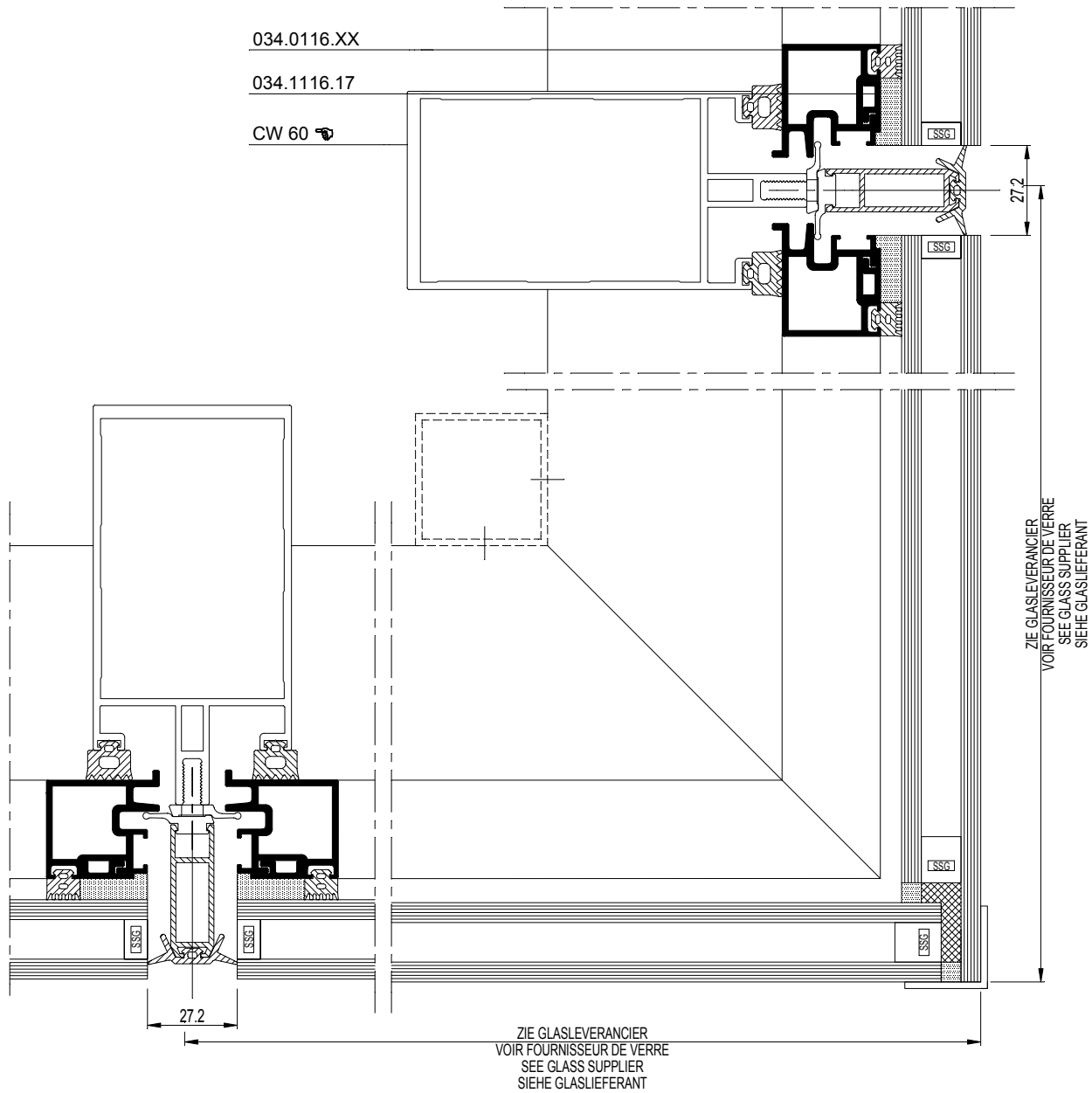

ZIE GLASLEVERANCIER
VOIR FOURNISSEUR DE VERRE
SEE GLASS SUPPLIER
SIEHE GLASLIEFERANT

ZIE GLASLEVERANCIER
VOIR FOURNISSEUR DE VERRE
SEE GLASS SUPPLIER
SIEHE GLASLIEFERANT

CW60-320001.dxf
CW60-320001.dwg

	325	

