

BS 40

BS 40



REYNAERS
aluminium

Edition 11/2010 (based on 089.J56B.00)

BS 40



BS 40

- 1 Inbouw
- 2 Muurmontage

BS 40

- 1 Encastrement
- 2 Montage Contre Le Mur

BS 40

- 1 Build In
- 2 Wall Mounted

BS 40

- 1 Einbau
- 2 Montiert Jegen Mauer



1 Inbouw Encastrement Build In Einbau

Vast paneel
Panneau Fixe
Fixed Panel
Festes Laden

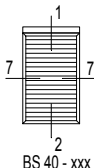

BS 40 - xxx

1 Rail

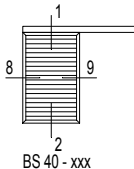

BS 40 - xxx

2 Rail

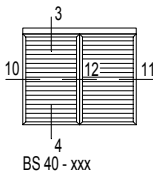

BS 40 - xxx

3 Rail

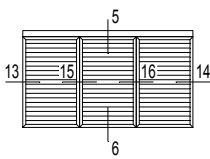

BS 40 - xxx

1 Muurmontage Montage Contre Le Mur Wall Mounted Montiert Jegen Mauer

Vast paneel
Panneau Fixe
Fixed Panel
Festes Laden

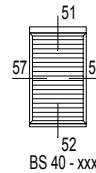

BS 40 - xxx

1 Rail

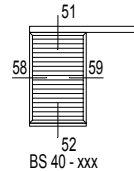

BS 40 - xxx

2 Rail

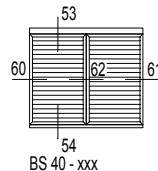

BS 40 - xxx

3 Rail

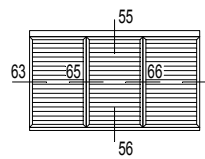

BS 40 - xxx

64

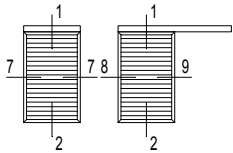

1

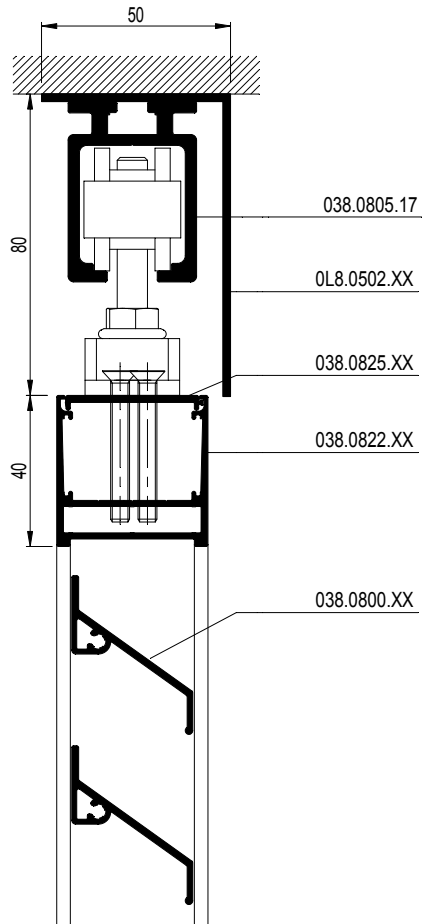

... .dxf
dwg



038.0800.XX

$I_x = 1.195 \text{ cm}^4$

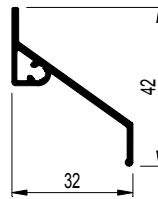

1 BS40-001001.dxf
 BS40-001001.dwg

038.0801.XX

$I_x = 0.876 \text{ cm}^4$

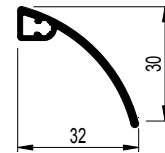

1 BS40-001002.dxf
 BS40-001002.dwg

2

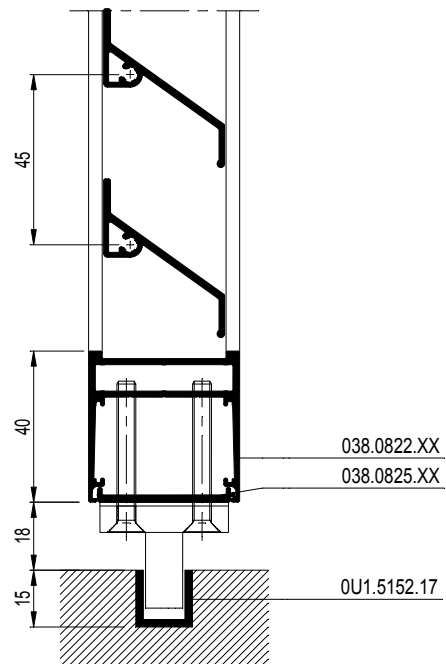

BS40-002001.dxf
 BS40-002001.dwg

7

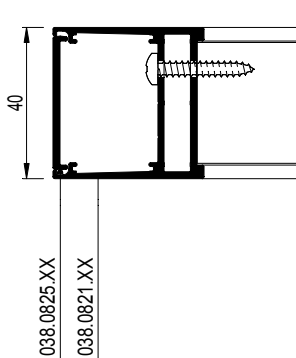

BS40-007001.dxf
 BS40-007001.dwg

BS 40

Inbouw - 1 Rail
Encastrement - 1 Rail
Build In - 1 Rail
Einbau - 1 Schiene

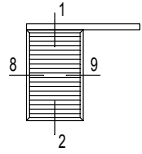

8

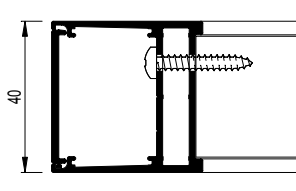

BS40-008001.dxf
BS40-008001.dwg

9

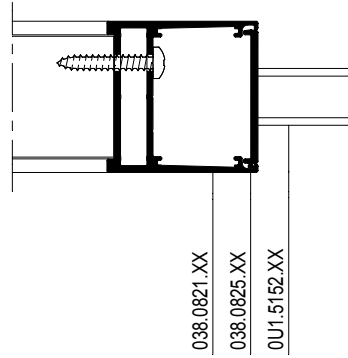

BS40-009001.dxf
BS40-009001.dwg

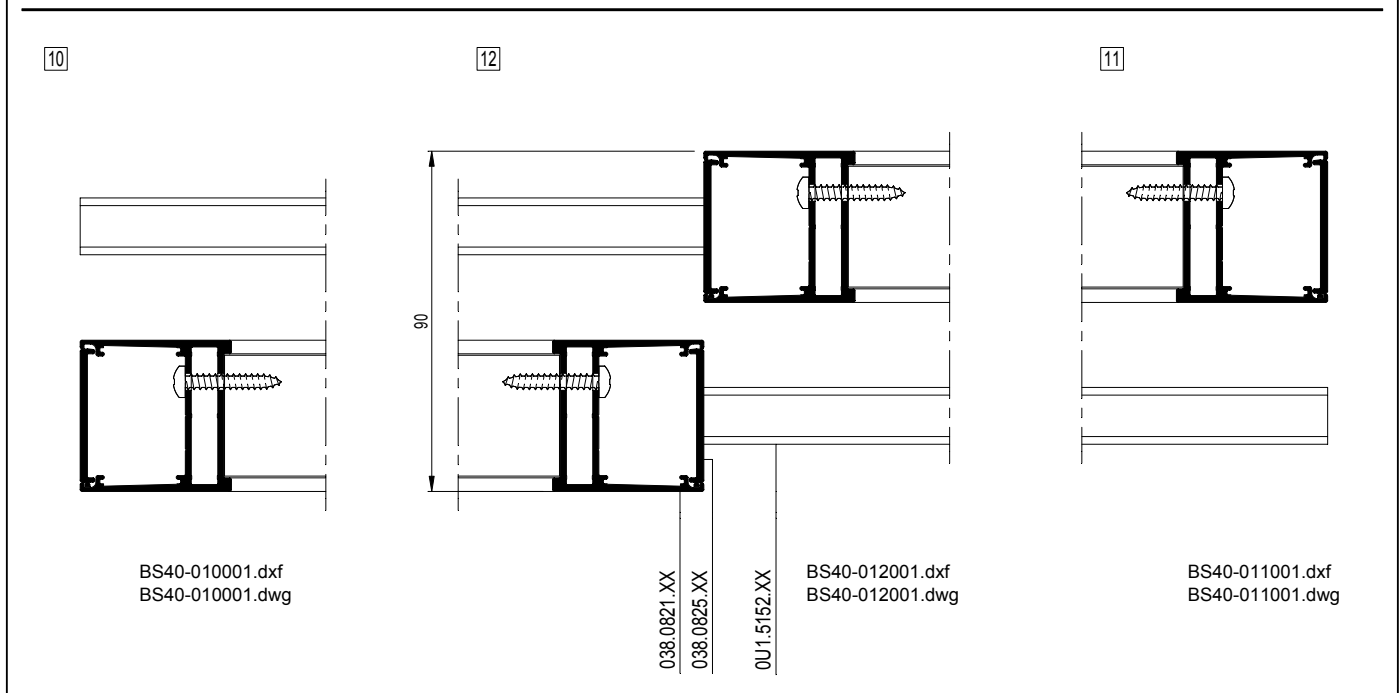
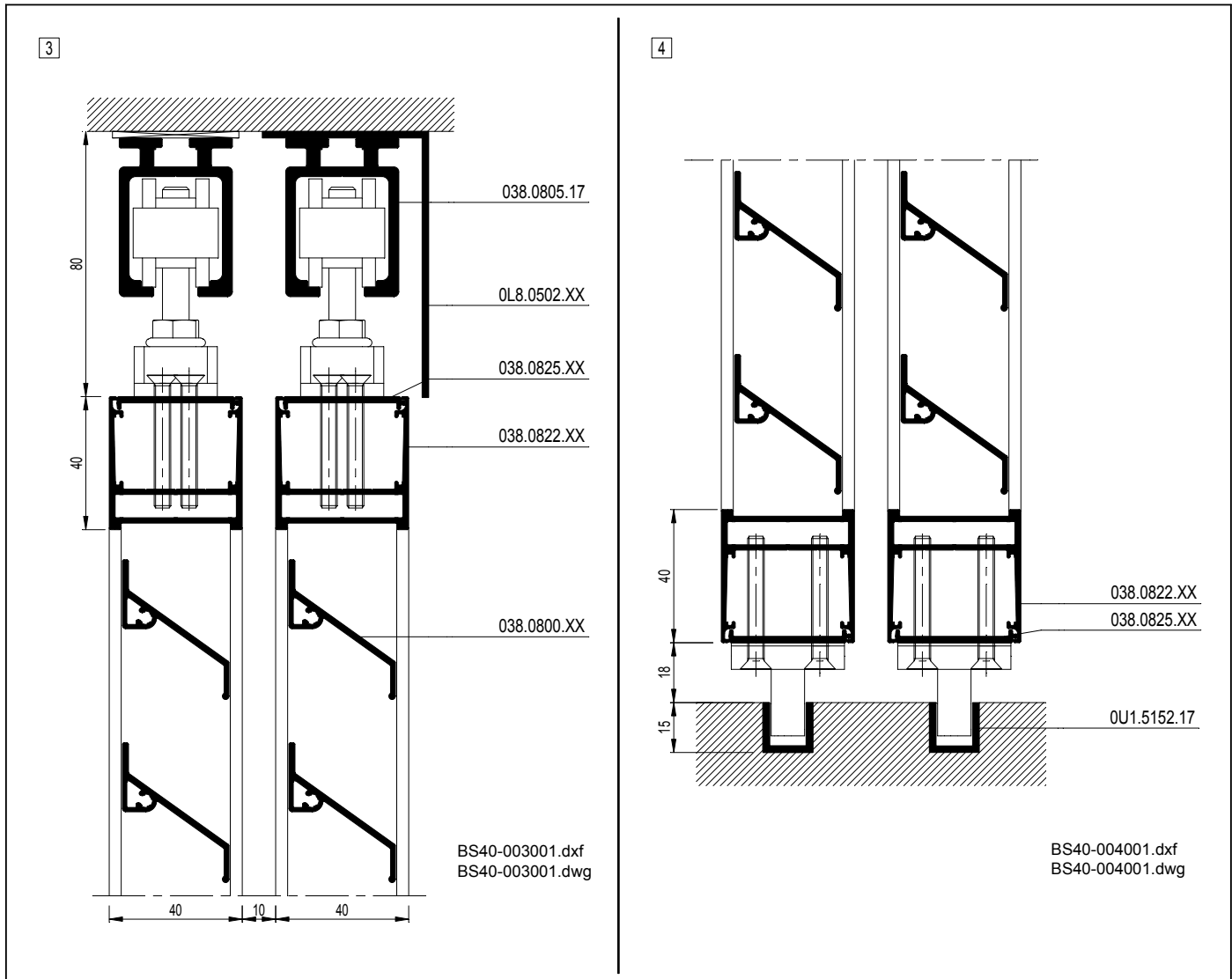
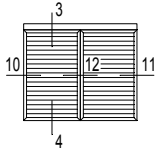

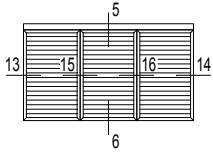

5

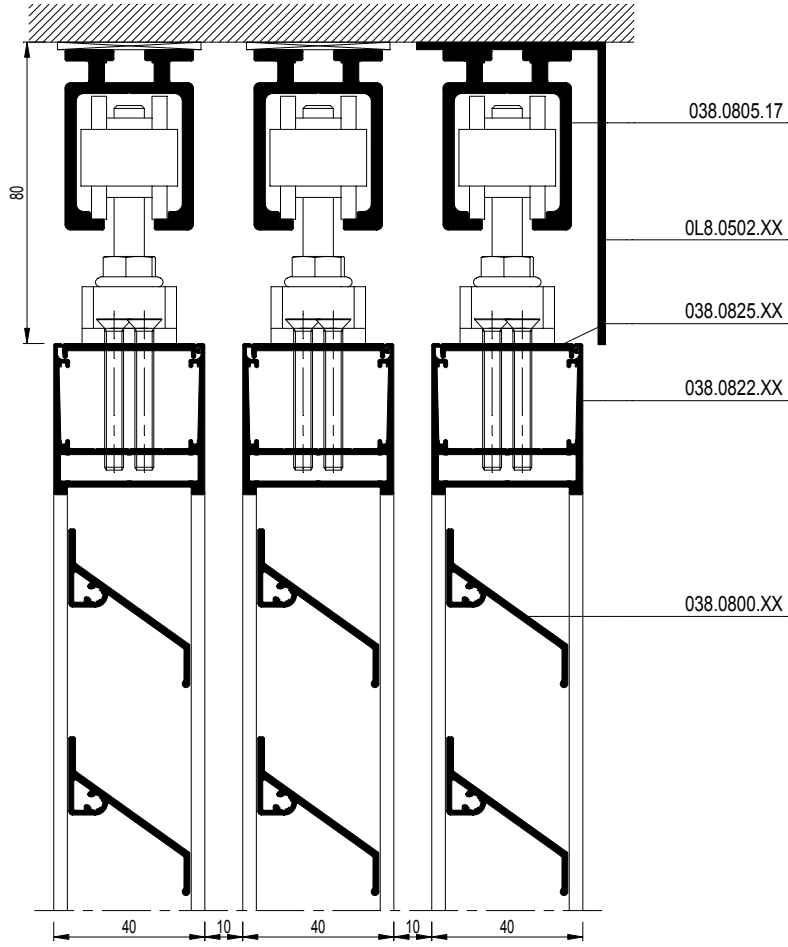

BS40-005001.dxf
 BS40-005001.dwg

6

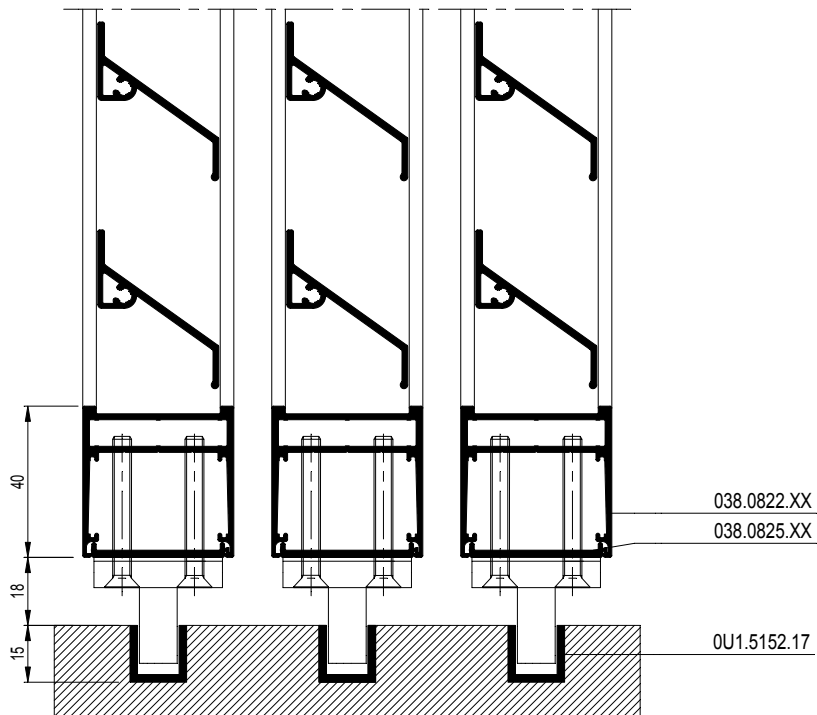

BS40-006001.dxf
 BS40-006001.dwg

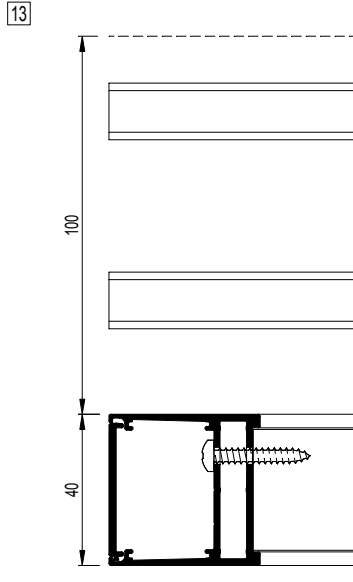
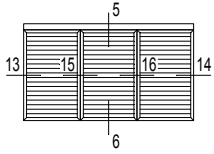

BS40-013001.dxf
 BS40-013001.dwg

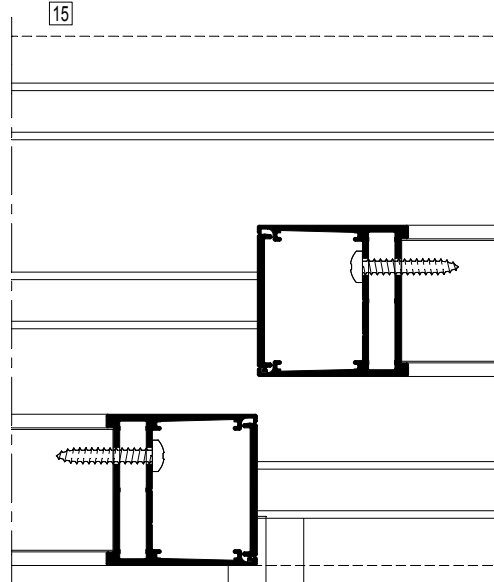

038.0821.XX
 038.0825.XX
 001.5152.XX

BS40-015001.dxf
 BS40-015001.dwg

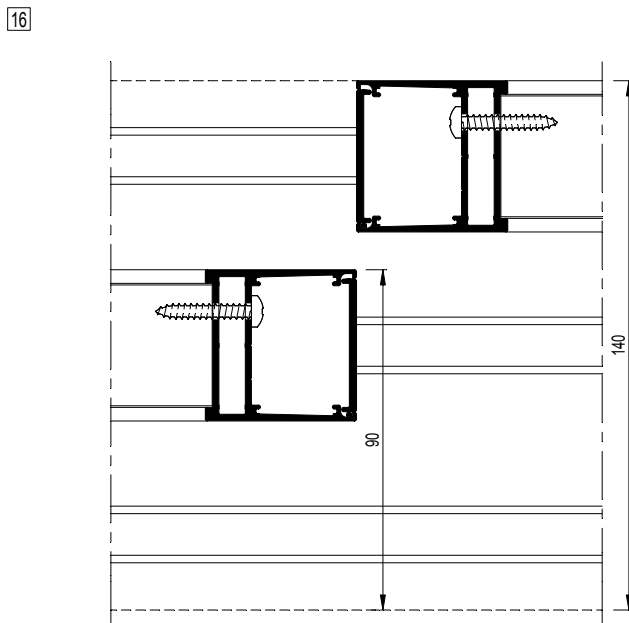

BS40-016001.dxf
 BS40-016001.dwg

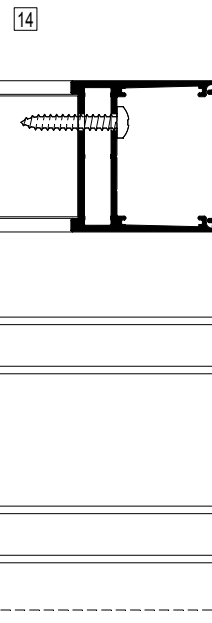

BS40-014001.dxf
 BS40-014001.dwg

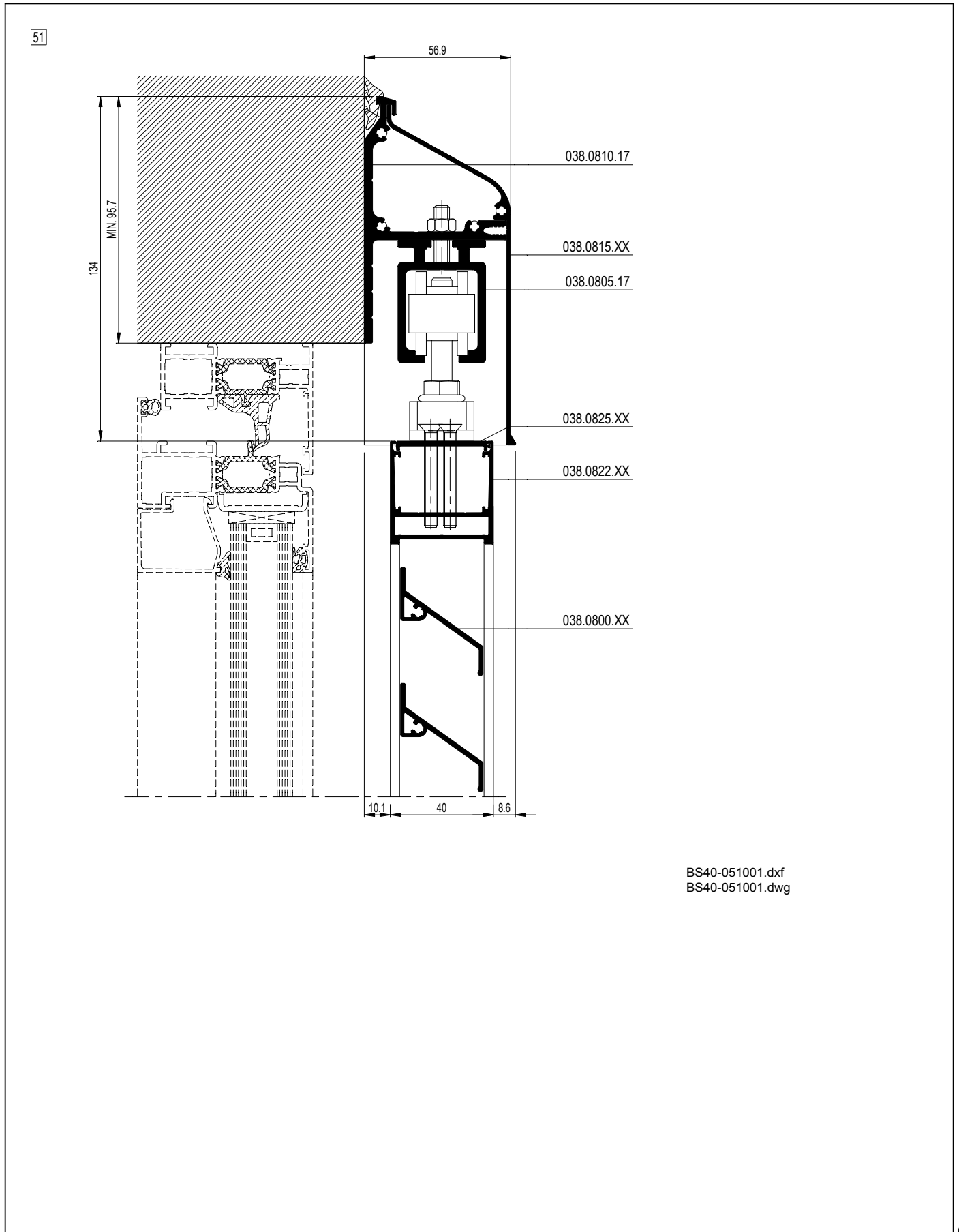
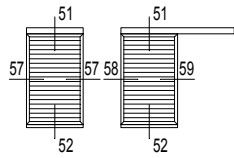

BS40-051001.dxf
BS40-051001.dwg

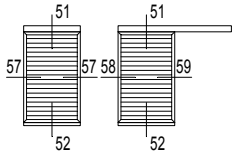

52

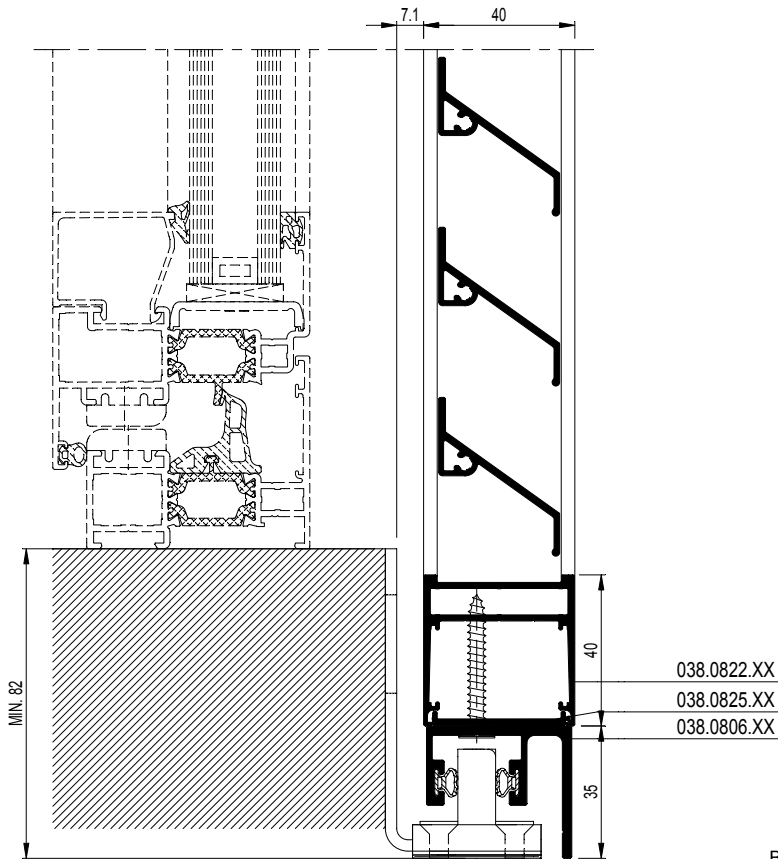

BS40-052001.dxf
 BS40-052001.dwg

57

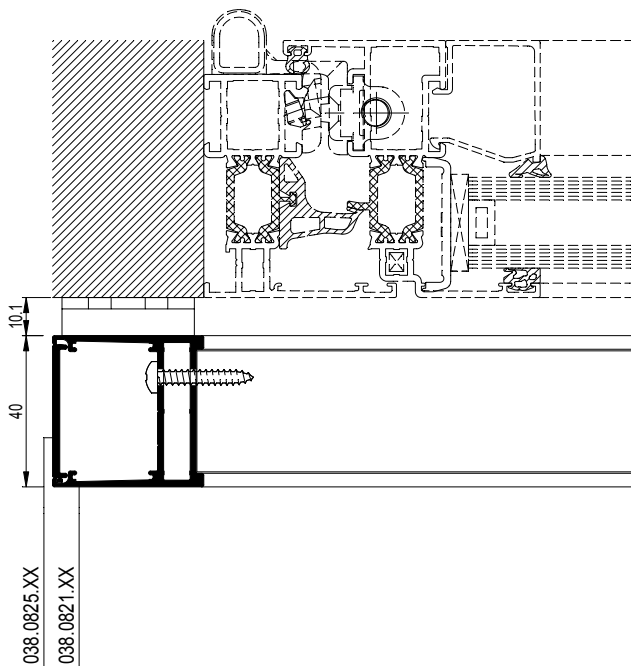

BS40-057001.dxf
 BS40-057001.dwg

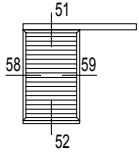

58

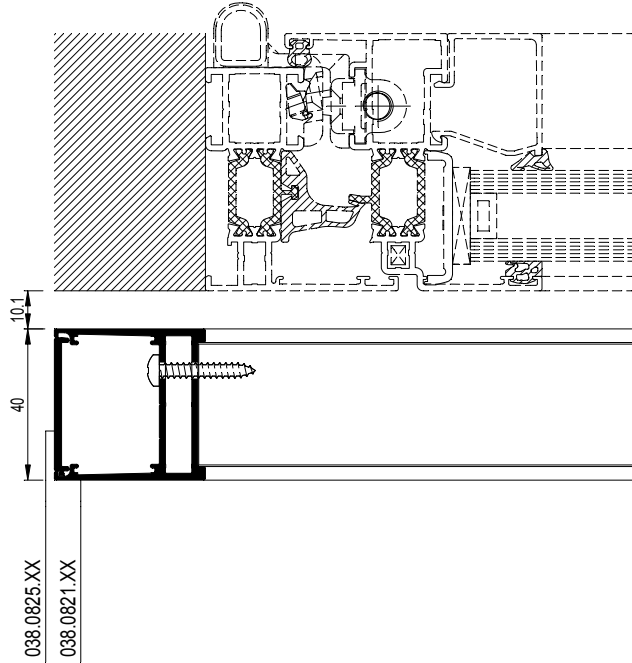

BS40-058001.dxf
BS40-058001.dwg

59

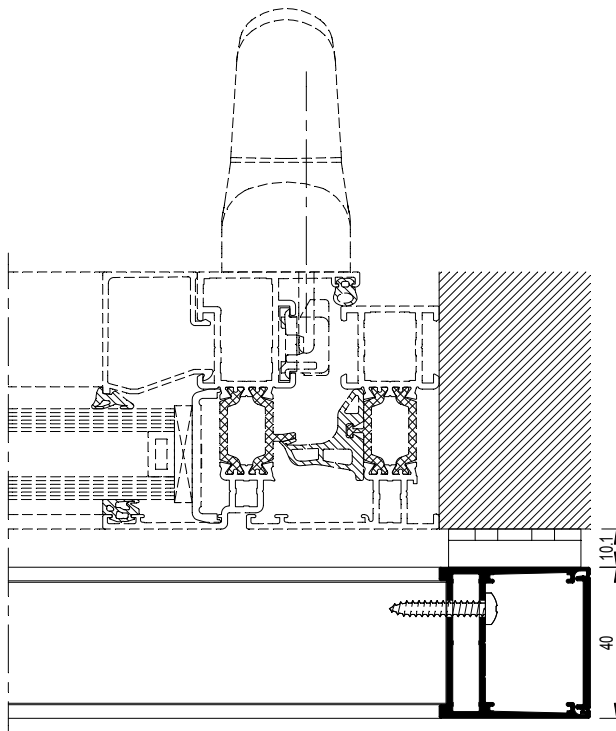

BS40-059001.dxf
BS40-059001.dwg

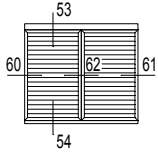

53

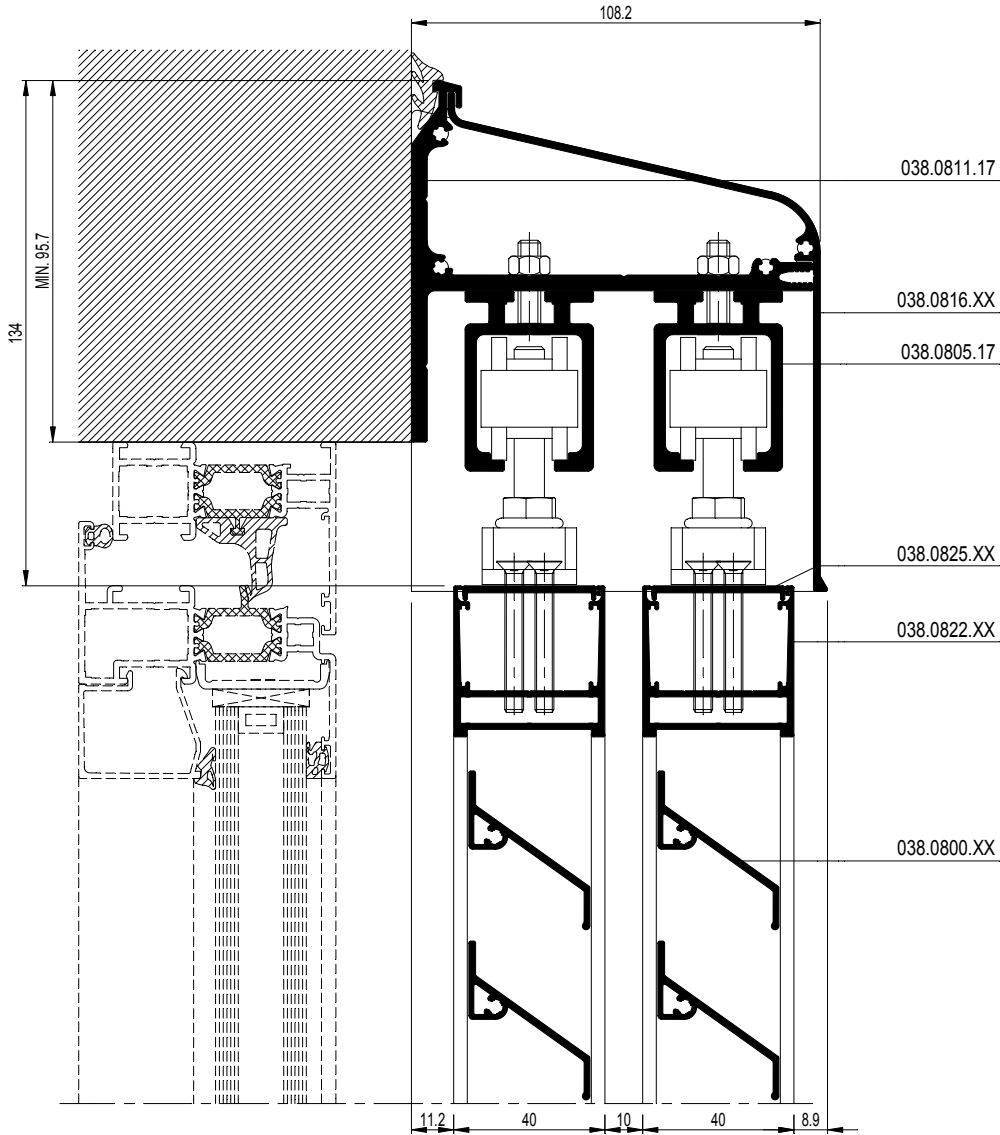

BS40-053001.dxf
BS40-053001.dwg

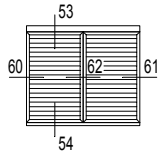

54

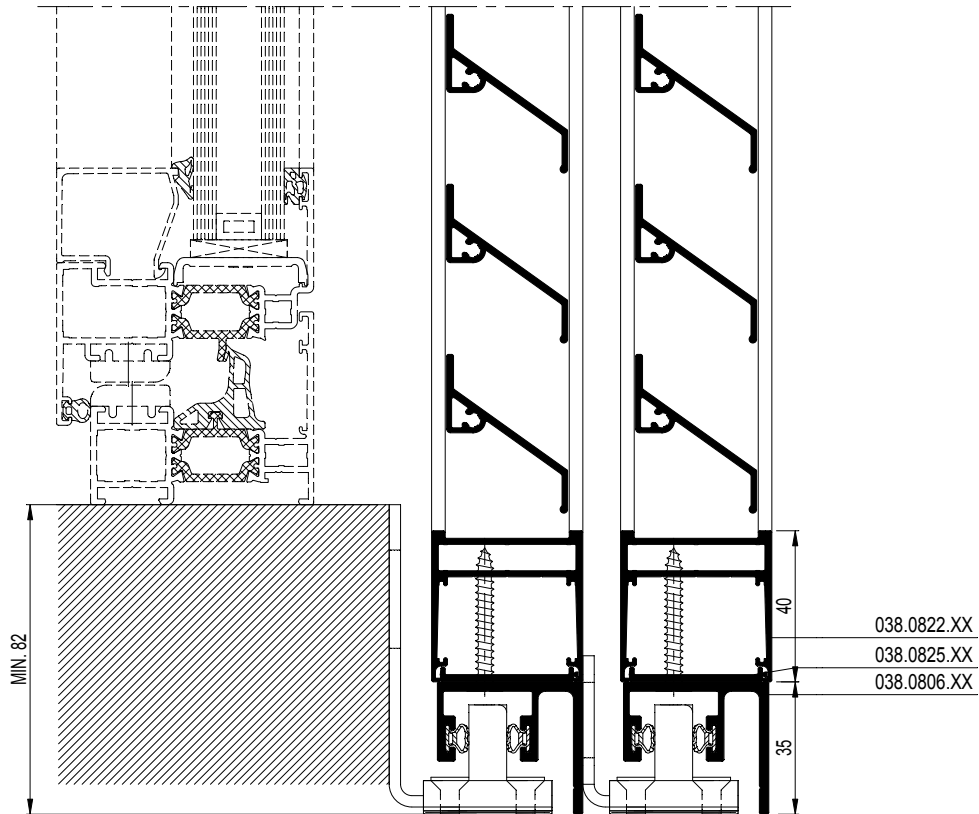

BS40-054001.dxf
BS40-054001.dwg

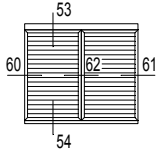

60

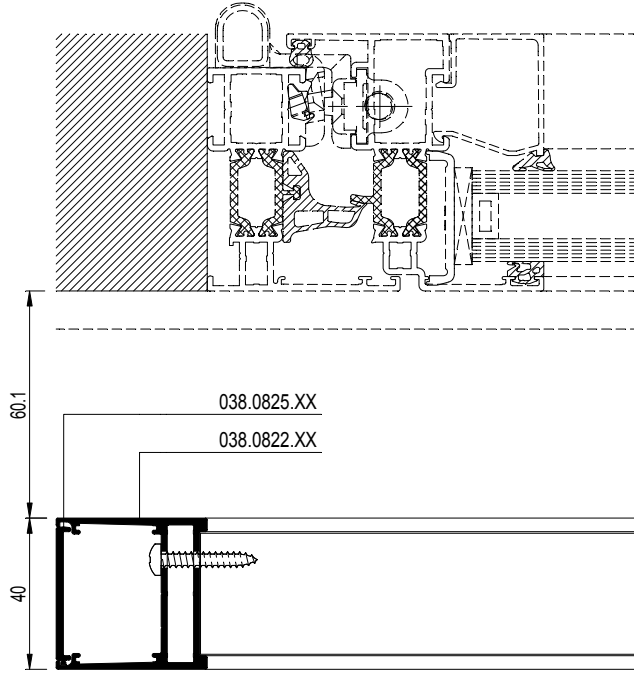

BS40-060001.dxf
BS40-060001.dwg

62

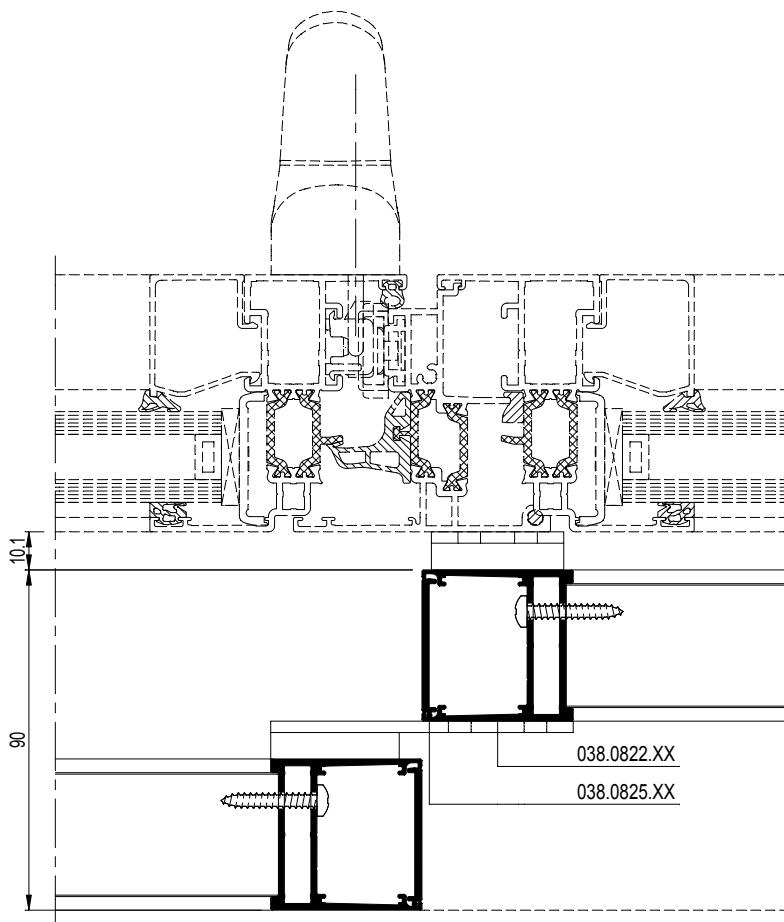

BS40-062001.dxf
BS40-062001.dwg

BS 40

Muurmontage - 2 Rails
Montage Contre Le Mur - 2 Rails
Wall Mounted - 2 Rails
Montiert Jegen Mauer - 2 Schienen

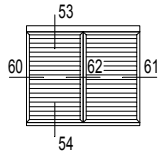

61

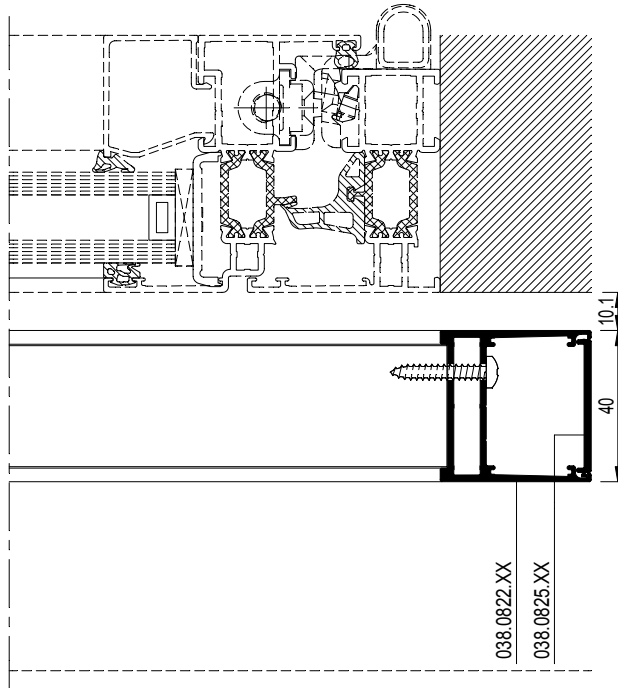

BS40-061001.dxf
BS40-061001.dwg

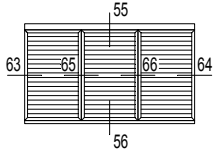

55

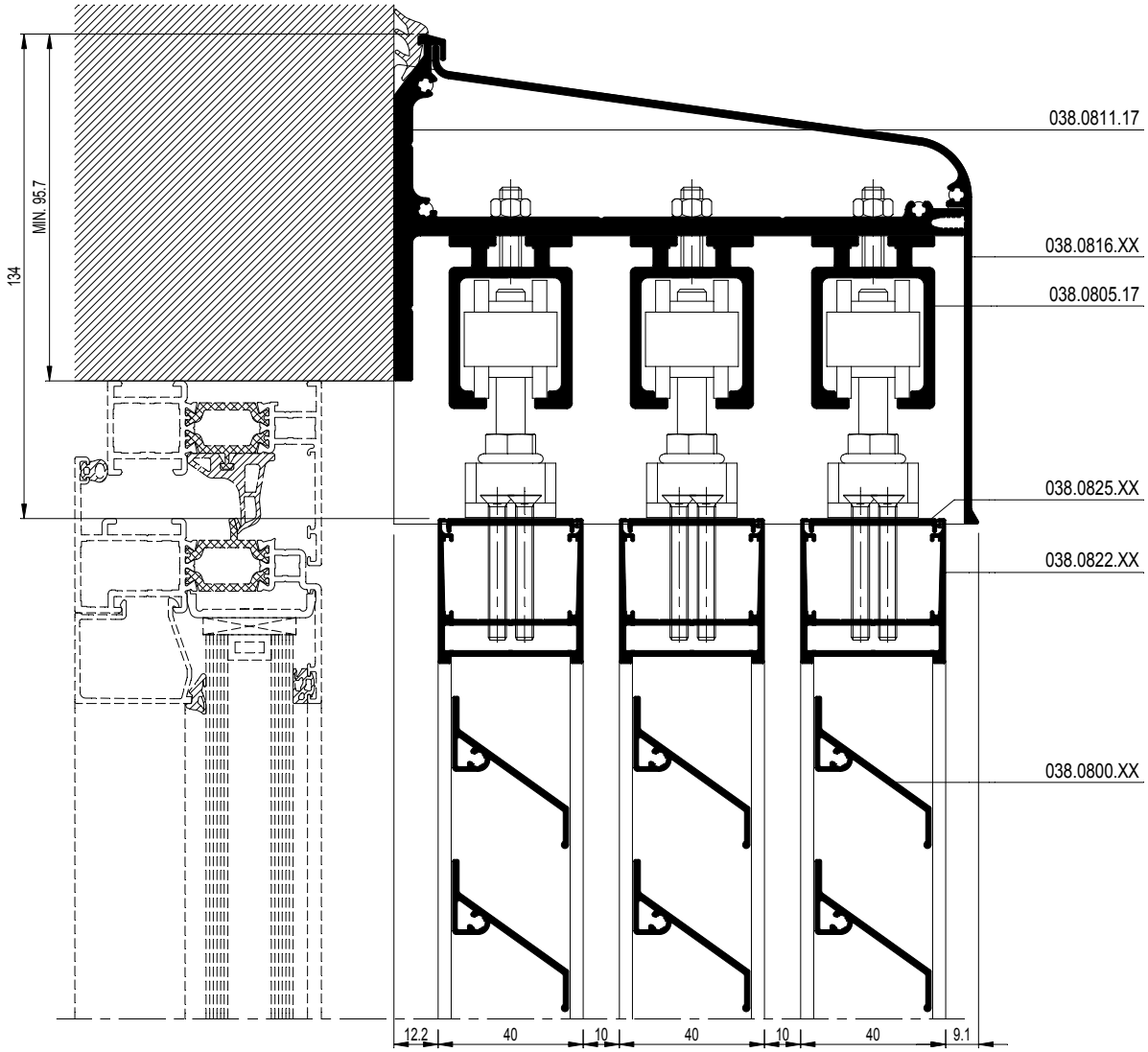

BS40-055001.dxf
BS40-055001.dwg

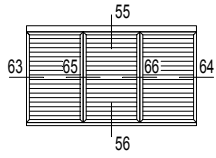

56

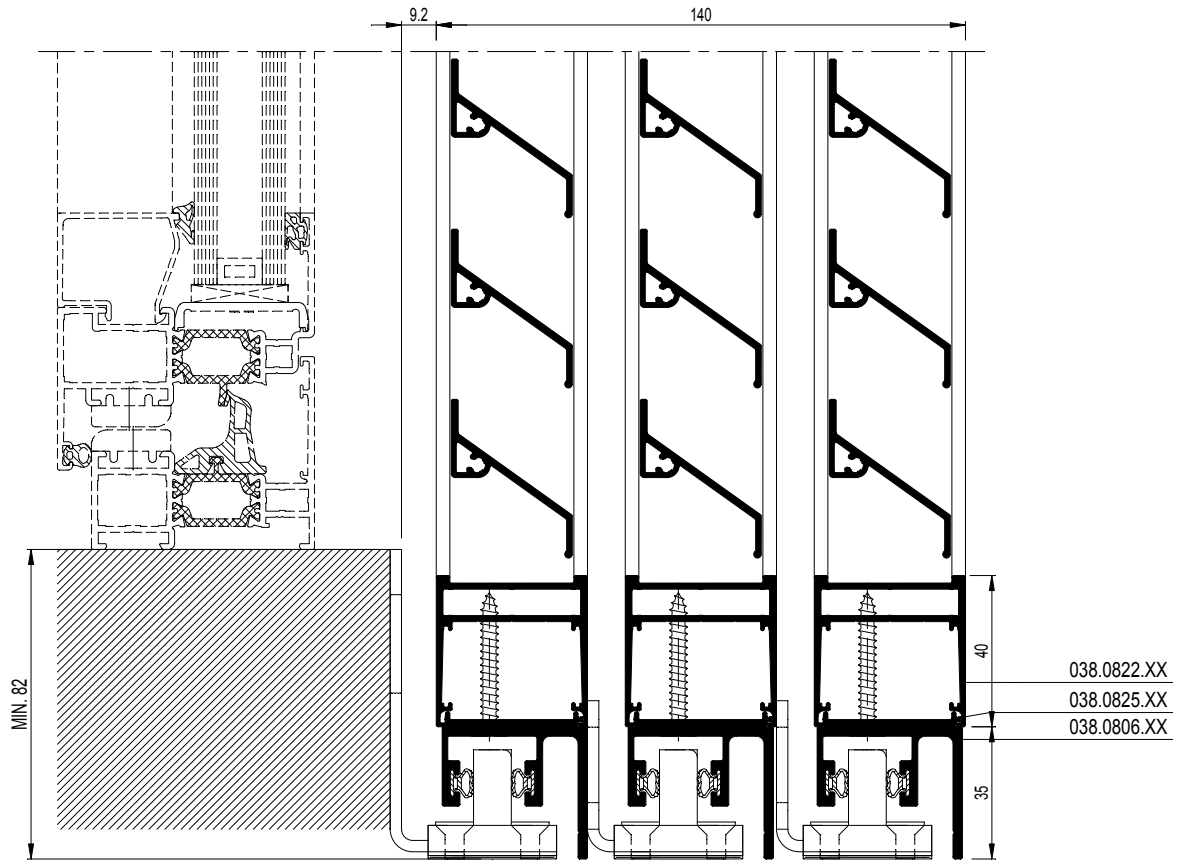

BS40-056001.dxf
BS40-056001.dwg

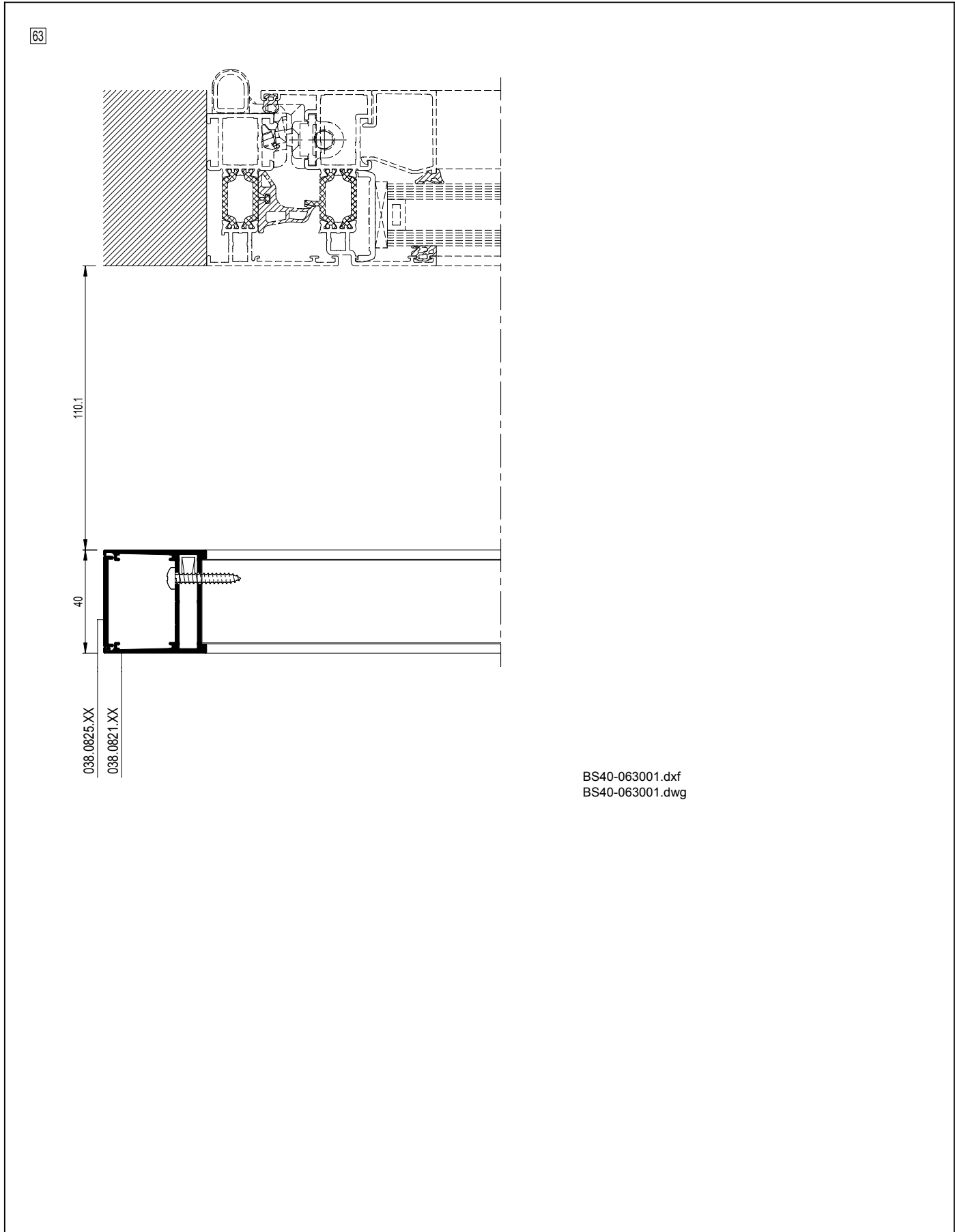
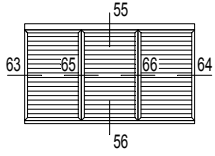

BS40-063001.dxf
BS40-063001.dwg

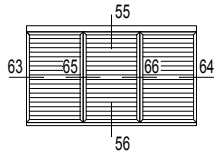

65

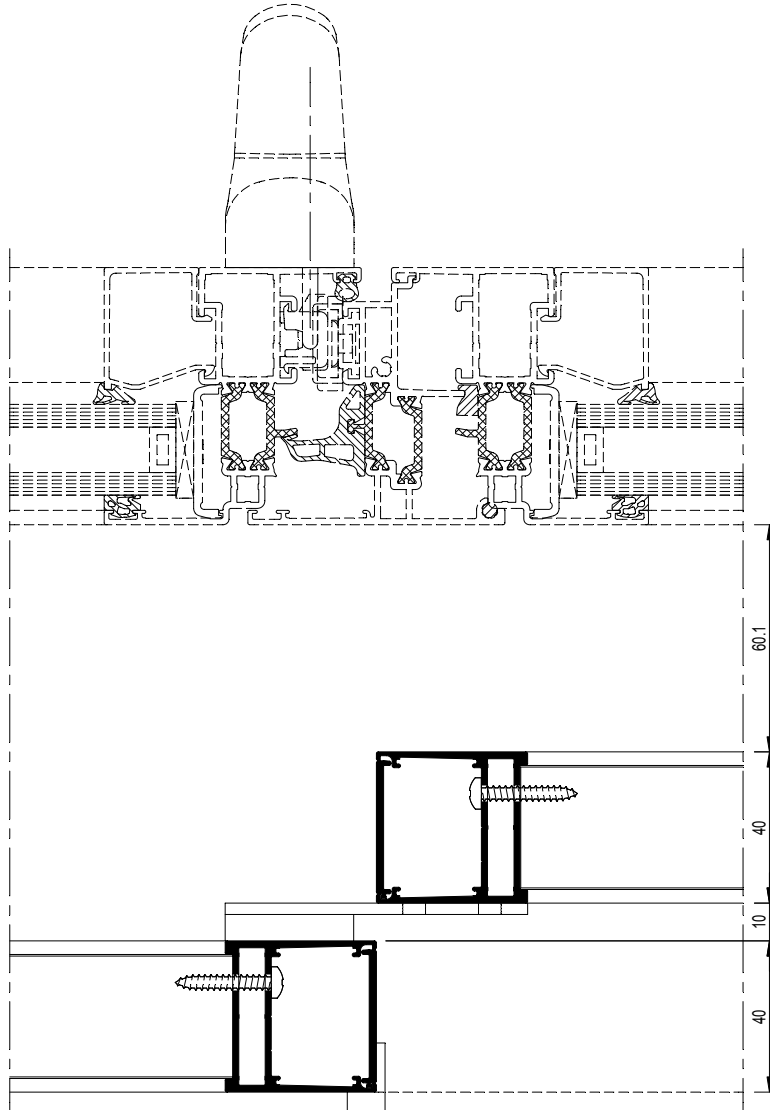

038.0821.XX
038.0825.XX

BS40-065001.dxf
BS40-065001.dwg

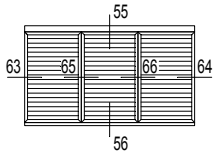

66

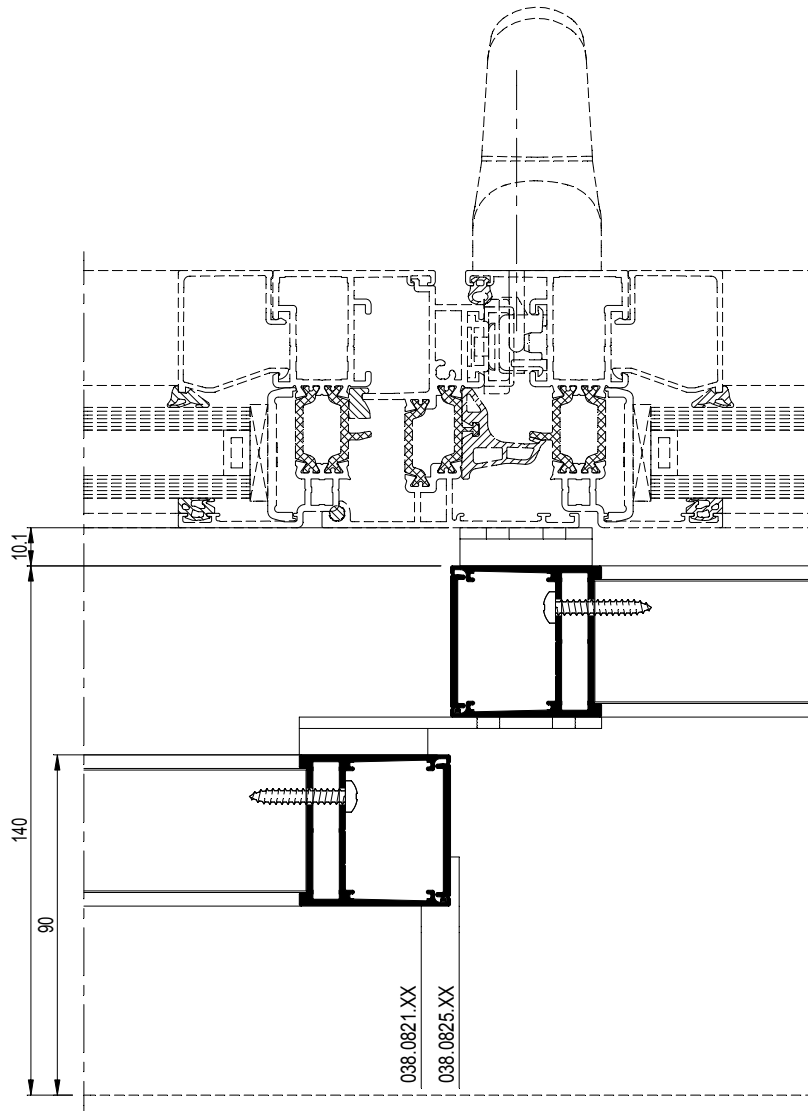

BS40-066001.dxf
BS40-066001.dwg

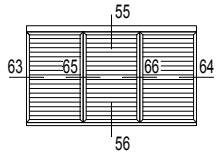

64

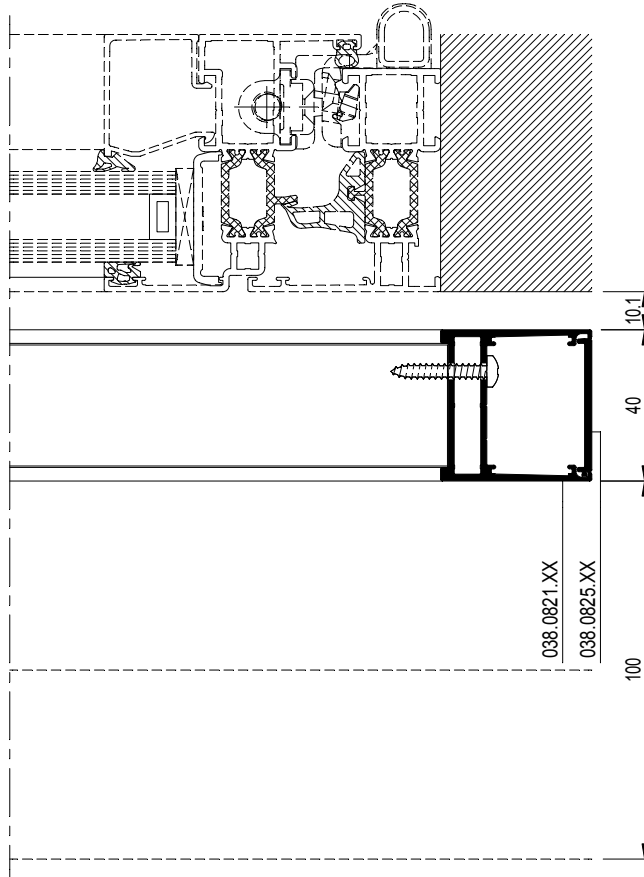

BS40-064001.dxf
BS40-064001.dwg